

moldingknives.com



**Knives to fit the
Craftsman
planer moulder**

**We manufacture molding knives
to fit most molders in both
High Speed Steel and Carbide**

Dear Craftsman Planer Moulder Owner,

Welcome to our first catalogue dedicated to knives to fit the Craftsman planer molder

The growing popularity of the Craftsman Planer Moulder has created a need for both stock profiles to fit your machine, and a flexible range of custom knives. We know what your machine will do (an almost endless variety of profiles!), as we have made hundreds of knives to fit all models of Craftsman Planer Molders.

Our knives are made in Canada to the highest quality standards from European made M2 HSS. We also offer carbide knives for you to machine MDF.

Competitive prices, fast turnaround, and experience are all on your side when you order from us.

One knife versus three knives....

While the Craftsman Planer Moulder has a three slot cutterhead there are some less aggressive cuts where you can run a single knife with a Balance Kit. This is determined by a number of factors:

- species of wood/ material being run
- moisture content of wood/ material being run
- amount of wood that needs to be removed

Please contact us to with any questions regarding one knife versus three knives for your run.

Contents

BACK RELIEF KNIVES.....	8
ASTRAGAL	9
BACK BAND	10
BAR RAIL.....	11
BASE CAPS.....	12
BASE MOLDINGS.....	13
BASE SHOES.....	16
BATTENS	16
BEADBOARD	17
BEDS	19
BRICK MOLDING	20
BULLNOSE	21
CABINET MOLDINGS	23
CASINGS	24
COLONIAL CASINGS	31
CHAIR RAILS	33
COVES	34
CROWN MOLDING	36
CURVES.....	49
DESIGNER KNIFE SERIES.....	51
DOWELLING KNIVES	54
GLASS BEAD	57
HAND RAIL	58
HEADER	59
MITRED DOORS.....	60
PANEL STRIPS / MULLION CASINGS.....	62
PICTURE MOLDINGS	63
PLANTATION LOUVERS / SHUTTERS	64
QUARTER ROUNDS.....	67
SHELF EDGE / SCREEN MOLD.....	68
SHINGLE / PANEL MOLDINGS.....	69
STOPS	70
TONGUE AND GROOVE.....	71
V's.....	80
WAINSCOT / PLYCAP MOLDINGS.....	81
WAINSCOTTING.....	82
WOOD PLANK PANELLING / SIDING	84
THE EASY WAY TO ORDER KNIVES.....	90

[Click Here for price list.](#)

Check out our website for more profiles.

www.moldingknives.com

CUSTOM PATTERN KNIVES

The versatility of the Craftsman planer / moulder and the ingenuity of our customers will be apparent on the pages of this catalogue. In addition to our catalogue knives, we have hundreds of different custom profiles to fit Craftsman planer / moulders. In addition to moldings, our customers also manufacture flooring, decking, siding, core boxes and a wide variety of diverse products.

Moldingknives.com has pioneered a new and better way of manufacturing molding knives. Using state-of-the-art CNC technology, our knives are machined in-house, to exacting tolerances, and from the finest of tools steels. We have the facilities and the experience to design, manufacture, and test knives to meet your specific need.

Check out these advantages:

CONVENIENCE

Order by phone, fax, or email without leaving your office. FED EX can deliver orders to most areas the next day (for in-stock knives) and you can charge it to your VISA, MASTERCARD, AMERICAN EXPRESS or DISCOVER. We also accept online payments via PAY PAY.

CHOICE

We have one of the largest inventories of molding knives in the world. Next-day delivery is available in most parts of The United States and Canada.

CUSTOM KNIVES

In most cases, custom knives are manufactured and shipped within 24 hours from receipt of your order. Now you can fill those custom molding orders *QUICK*.

QUALITY

Most of our knives are manufactured from industrial grade ASI M2 high-speed tool steel, heat-treated to a hardness of 62/64 HRC, to a finish and accuracy which only CNC equipment can guarantee. We also stock various grades of steels and carbide for special applications.

SPECIAL APPLICATIONS

We can also manufacture carbide and alloyed tool steel knives for special applications.

KNOWLEDGEABLE STAFF

Talk to our staff; we know our products and take pride in our work. Over the years we have assisted many of our customers with custom knives for that special project.

VALUE

We use only the finest of tool steels. WE DO NOT USE THE CHEAP IMPORTED TOOL STEELS that some manufacturers do. Compare our prices; compare our knives in actual usage; they cut cleaner and stay sharp longer.

VERSATILITY

Moldingknives.com knives makes knives to fit virtually every brand of planer / moulder. We also make knives to fit most brands of shaper (including Craftsman shaper).

TYPES OF KNIVES

PLUNGE KNIFE

This versatile knife will machine the profile as shown and can be used on a variety of different widths. The molding blank must be machined to the correct thickness and width first. Economical plunge knives are available for a variety of moldings.

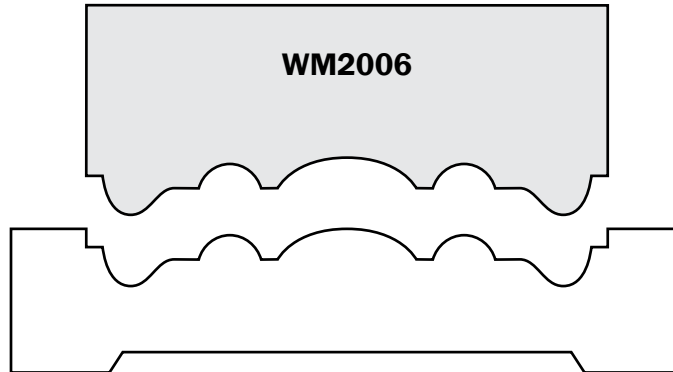

HALF KNIVES

Half-knives cut a little over half - so the profile blends in. They offer an obvious cost advantage for short runs. Two passes are required to complete this profile... Check with us for pricing.

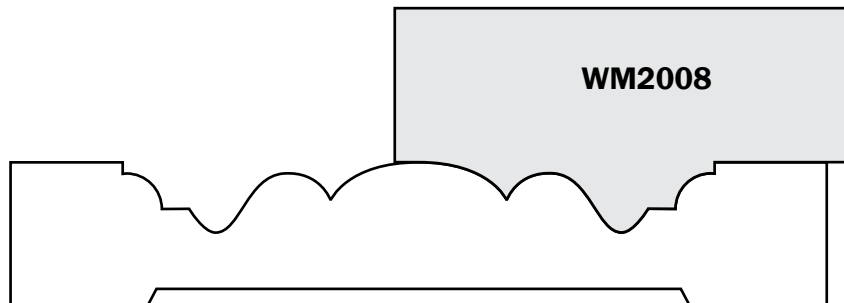

MULTIPLE CUT KNIVES

These knives have several advantages when manufacturing smaller moldings. They are referred to as 2-up knives and will make two pieces of molding in a single pass. Coves, quarter-rounds and glass beads can be produced with these knives in a single pass. They are also recommended for dowelling. Matched sets of three knives are recommended for most 2-up applications. We will be pleased to help you with your selection.

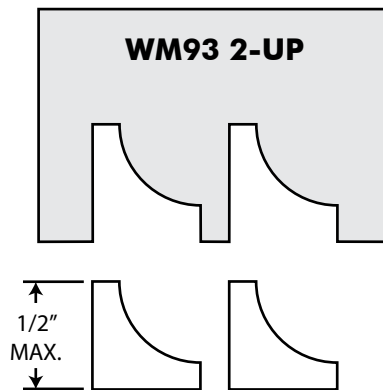

OPEN-ENDED KNIFE

Very popular for short runs of baseboards, They can be used on a variety of widths but you will have to finish your blank to the correct thickness and width beforehand. Open-ended knives are available for most baseboard patterns and also for many of the casings shown.

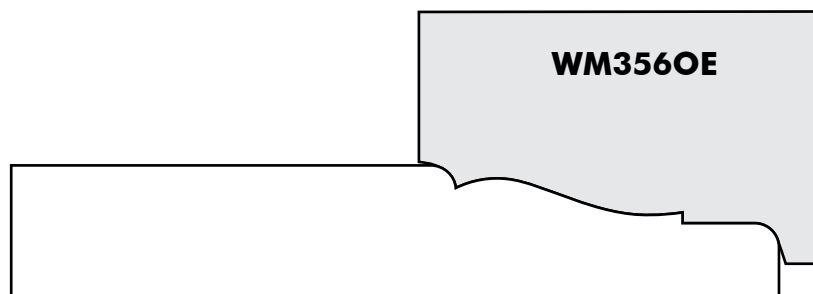

TOP AND BOTTOM KNIVES

Crown and many of the larger cove and bed moldings require two separate passes to produce the finished pattern, since the molding is cut on both the top and bottom. An example of these knives is shown below with the part number followed by the letter "T" for top and "B" for bottom knife.

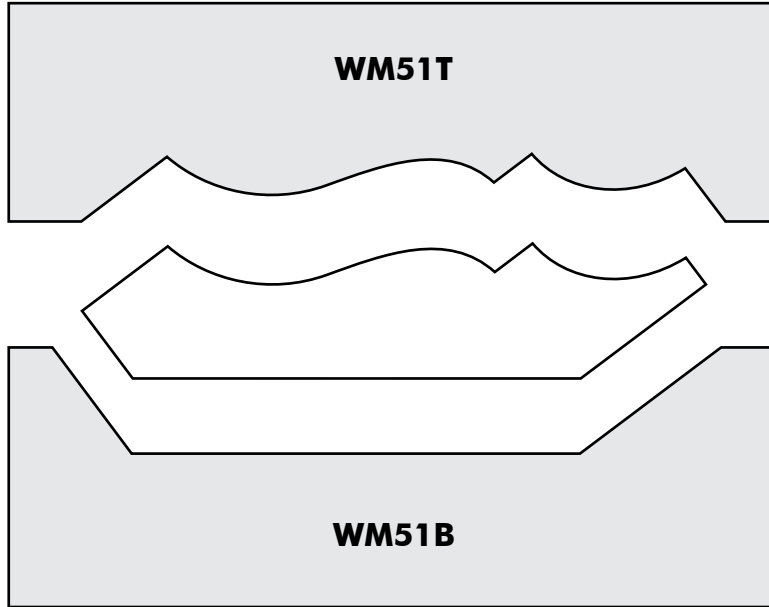

BACK RELIEF KNIVES

Used to machine the relief in moldings and flooring these knives are available in a variety of sizes and styles and are designated in the series shown.

REGULAR STYLE

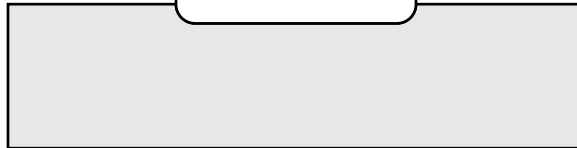

“B” STYLE



“B+” STYLE

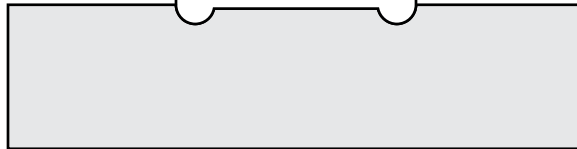

8TH EDITION PROFILE CATALOGUE

PUBLISHER:

moldingknives.com

EDITOR:

Fred Blois

ASSISTANT EDITOR

Craig Blois

LAYOUT/ARTWORK

Glenn MacKenzie

moldingknives.com

C/O: Woodmaster Tools of Canada

1176 Black Rock Road

Clifton, Nova Scotia B6L 1C1

Internet: <http://www.moldingknives.com>

Copyright © 2014

No part of this publication may be reproduced or transmitted in any form or by any means without the written permission of moldingknives.com.

ASTRAGAL

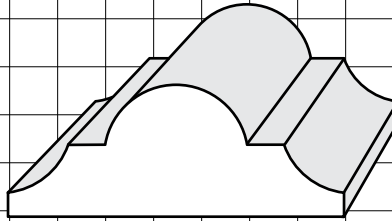

WM133

11/16" X 1-3/4"

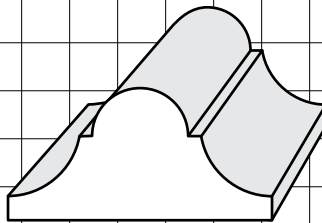

WM134

11/16" X 1-3/8"

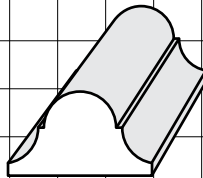

WM135

7/16" X 3/4"

BACK BAND

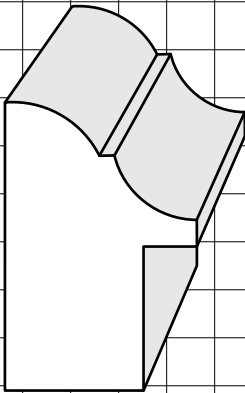

BB001
1-1/2" X 1"

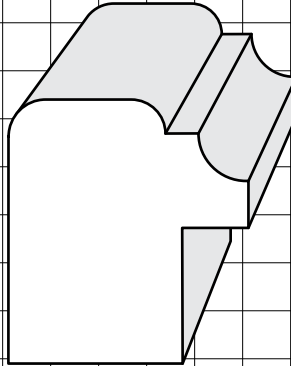

BB002
1-3/8 X 1-1/4"

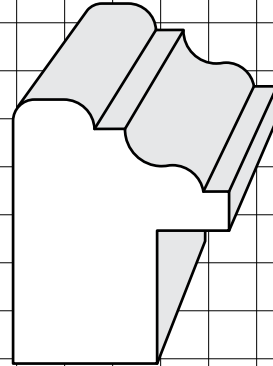

BB003
1-3/8 X 1-1/8"

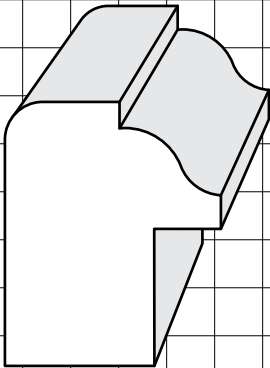

BB004
1-3/8 X 1-1/8"

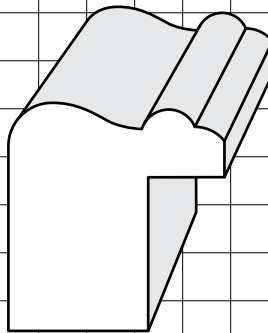

BB005
1-3/16 X 1-1/8"

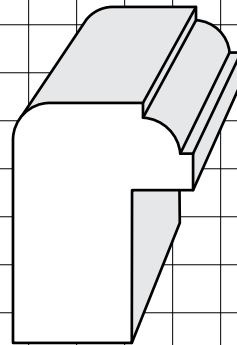

BB006
1-1/4 X 15/16"

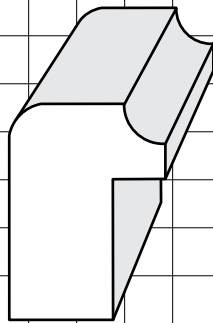

BB007
1-1/8" X 13/16"

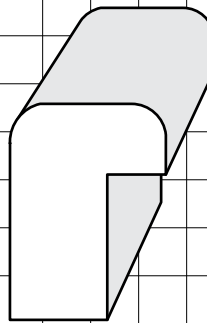

BB008
1-1/8" X 13/16"

BAR RAIL

A set of three top and three bottom knives are required to accomplish these moldings.

These knives require the use of a bedboard.

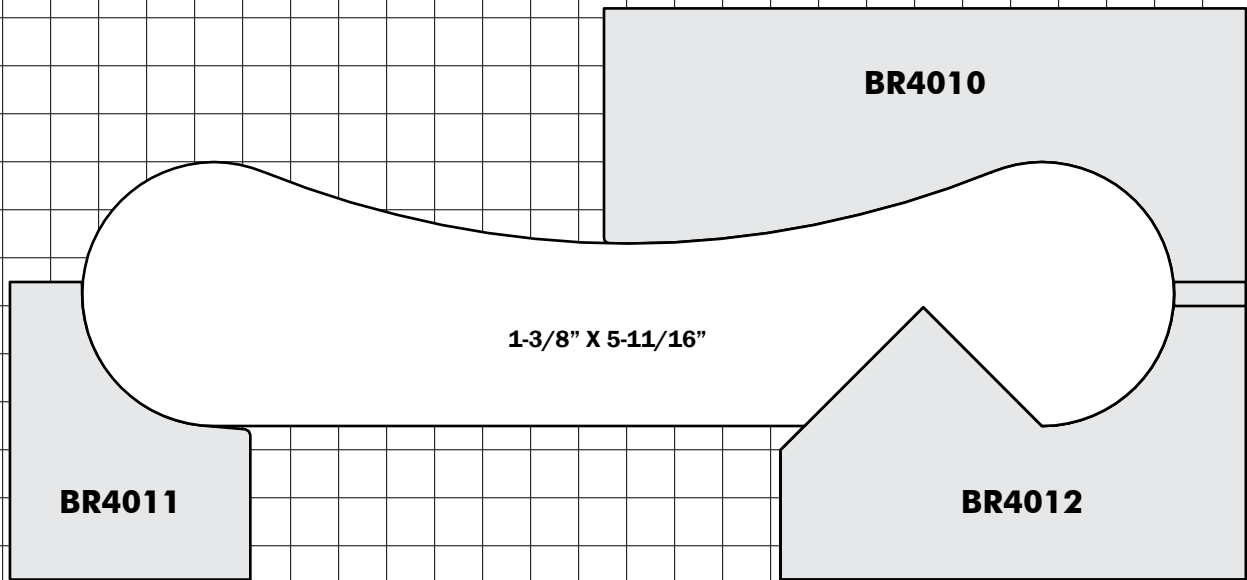

Ideal for planer / molders that have a maximum cutting depth of 3/4".

BASE CAPS

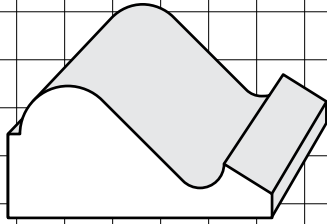

WM163
11/16" X 1-3/8"

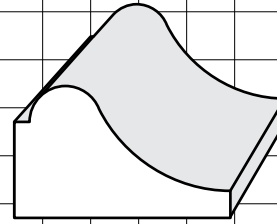

WM167
11/16" X 1-1/8"

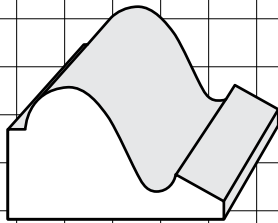

WM164
11/16" X 1-1/8"

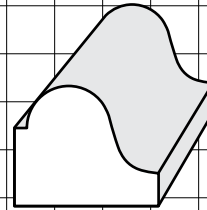

WM172
5/8" X 3/4"

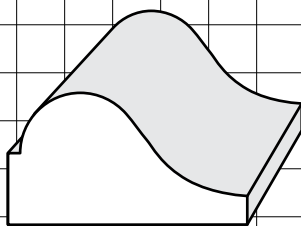

WM166
11/16" X 1-1/4"

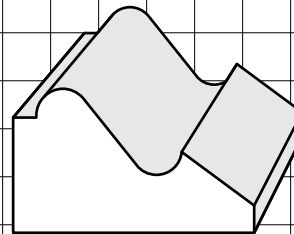

MK0043
3/4" X 1-1/4"

BASE MOLDINGS

Open-ended knives are available for these profiles.
These moldings require a back relief knife.

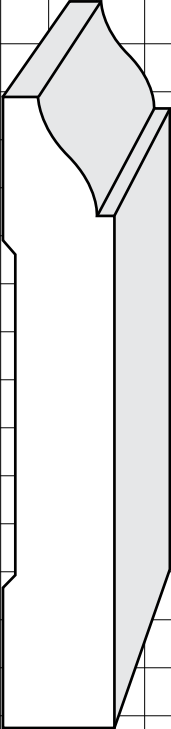

- WM 618** 9/16" X 5-1/4"
- WM620** 9/16" X 4-1/4"
- WM622** 9/16" X 3-1/2"
- WM623** 9/16" X 3-1/4" (Illus.)
- WM624** 9/16" X 3"

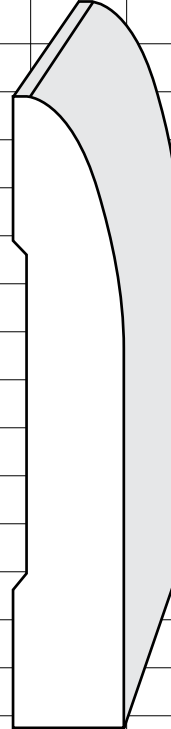

- WM709** 9/16" X 4-1/2"
- WM710** 9/16" X 4-1/4"
- WM712** 9/16" X 3-1/2"
- WM713** 9/16" X 3-1/4" (Illus.)
- WM714** 9/16" X 3"

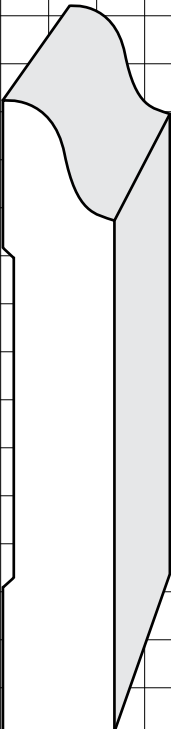

- WM658** 9/16" X 5-1/4"
- WM660** 9/16" X 4-1/4"
- WM662** 9/16" X 3-1/2"
- WM663** 9/16" X 3-1/4" (Illus.)
- WM664** 9/16" X 3"

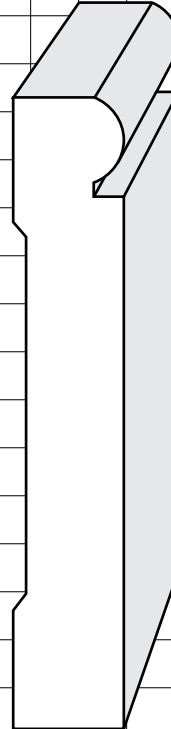

- WM750** 9/16" X 4-1/4"
- WM752** 9/16" X 3-1/2"
- WM753** 9/16" X 3-1/4" (Illus.)

BASE MOLDINGS

Open-ended knives are available for these profiles.
These moldings require a back relief knife.

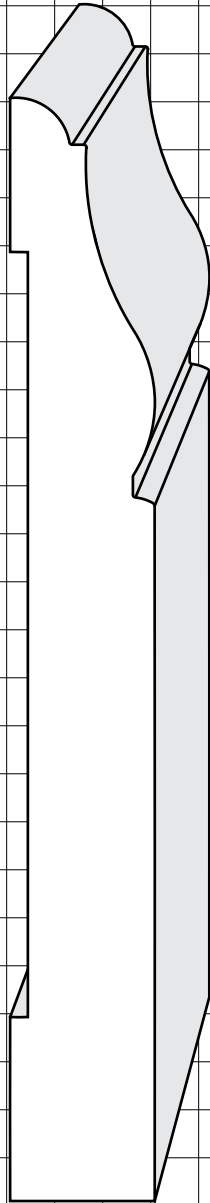

A11
3/4" X 5-3/4"

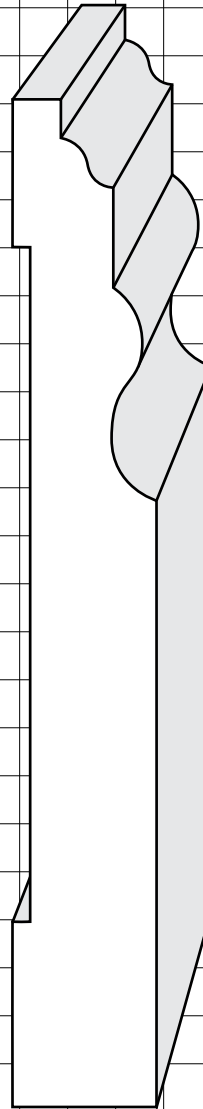

A12
3/4" X 5-1/4"

This knife requires the use
of a bedboard

BASE MOLDINGS

Open-ended knives are available for these profiles.
These moldings require a back relief knife.

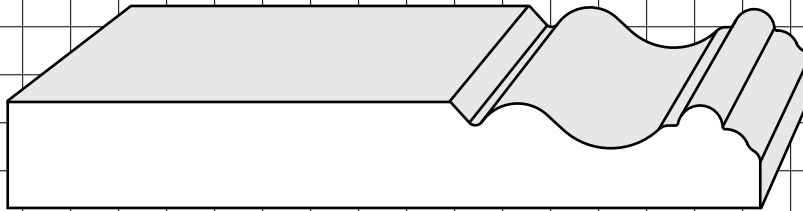

MK0681

11/16" X 1-3/8"

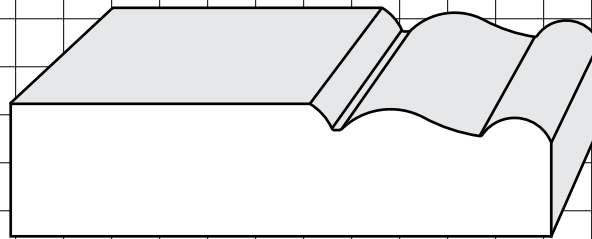

MK0682

11/16" X 2-13/16"

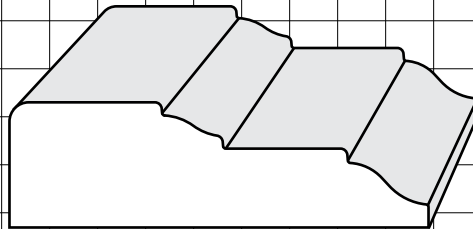

MK0683

11/16" X 1-1/4"

BASE SHOES

Recommend using 2-up knife to accomplish these moldings.

These knives are offered in a horizontal or vertical orientation depending on your preference.

These knives require the use of a bedboard.

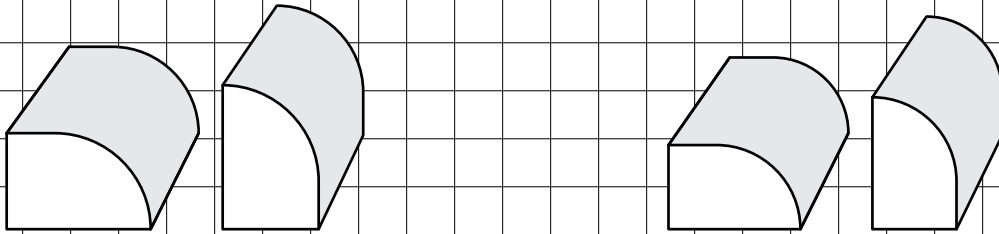

WM126
3/4" X 1/2"

WM129
11/16" X 7/16"

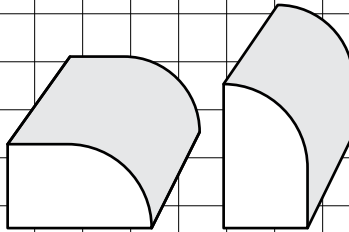

WM127
3/4" X 7/16"

BATTENS

These moldings require a back relief knife.

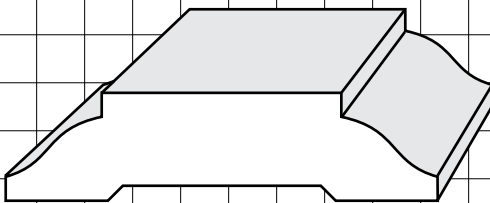

WM224
9/16" X 2-1/4"

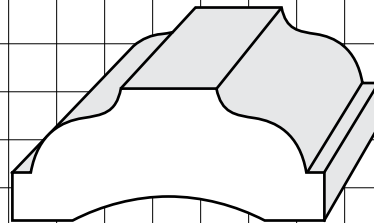

WM229
11/16" X 1-5/8"

BEADBOARD

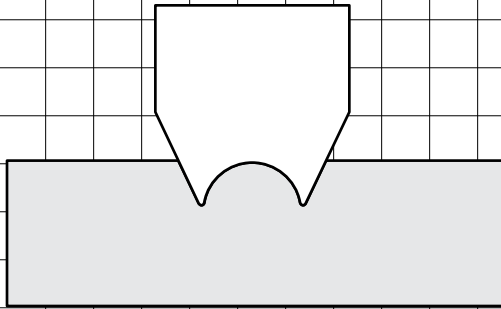

MK0060
1/2" Dia.

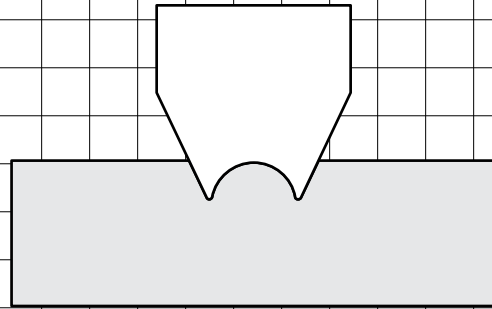

MK0061
7/16" Dia.

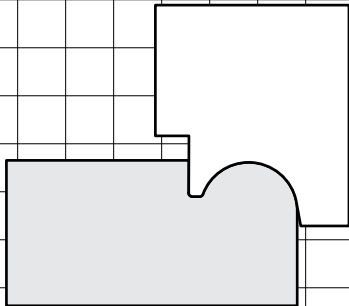

MK0064
1/2" Dia.

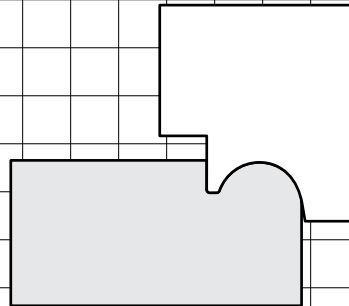

MK0066
7/16" Dia.

BEADBOARD

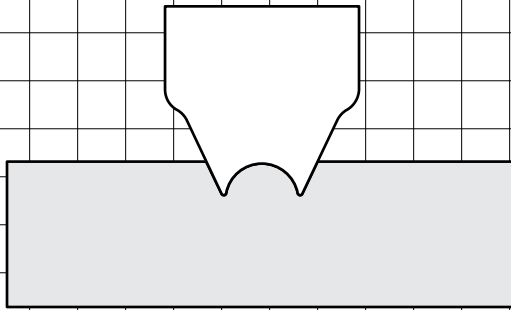

MK0062
3/8" Dia.

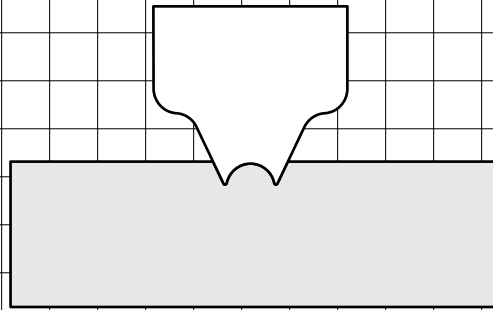

MK0063
1/4" Dia.

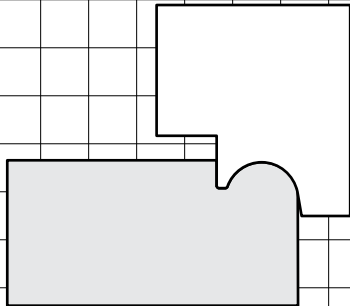

MK0068
3/8" Dia.

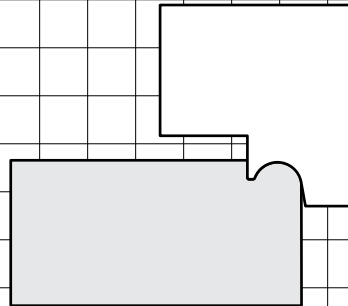

MK0070
1/4" Dia.

BEDS

These moldings require both a top and bottom knife.

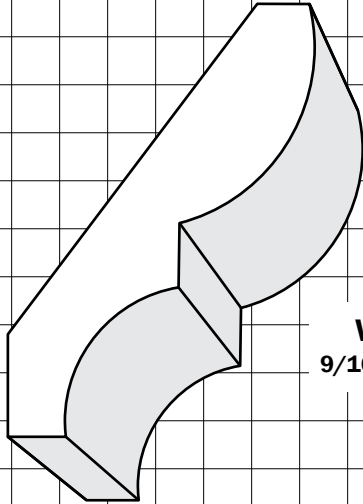

WM70
9/16" X 2-3/4"

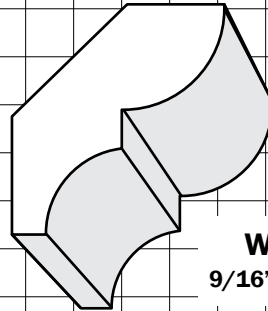

WM75
9/16" X 1-5/8"

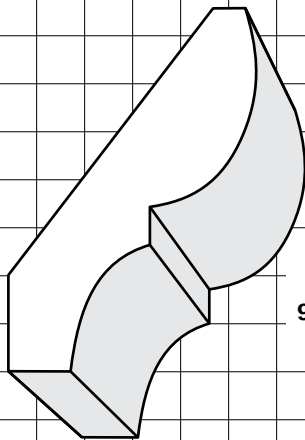

WM72
9/16" X 2-1/4"

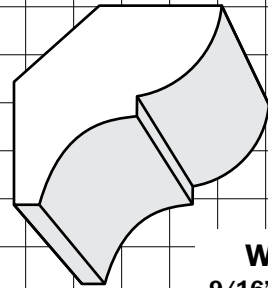

WM76
9/16" X 1-1/2"

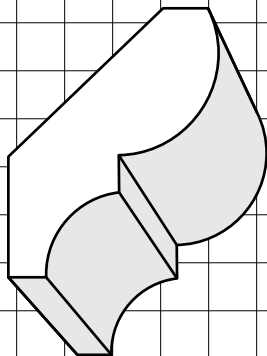

WM74
9/16 X 1-3/4"

BRICK MOLDING

Available only as plunge knives.

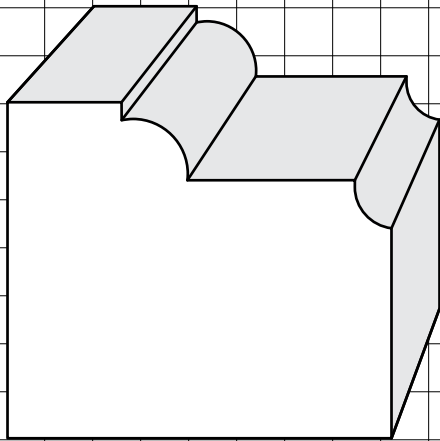

MK0019
1-3/4" X 2"

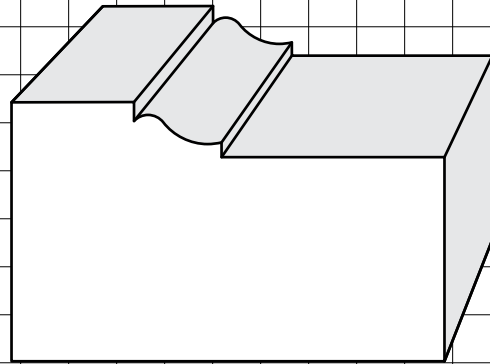

MK0023
1-5/8" X 2-1/4"

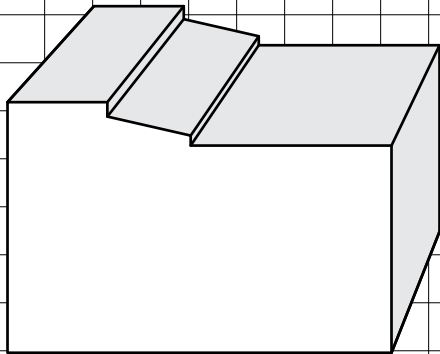

MK0025
1-5/8" X 2-1/4"

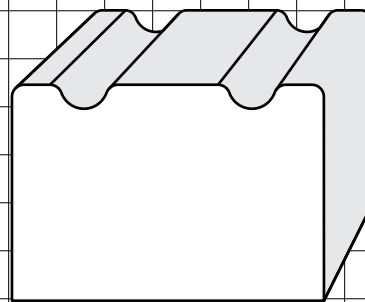

MK0030
1-1/8" X 1-5/8"

BULLNOSE

These knives are offered as a half-knife to be run as shown or a full knife which requires the stock to be run on its edge.

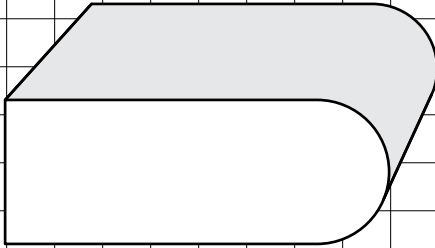

WM5004
3/4"

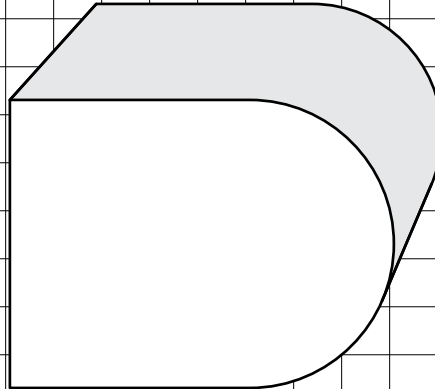

WM5006
1-1/2"

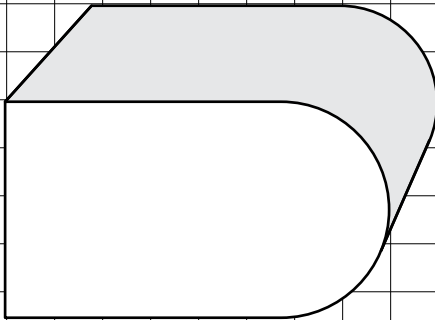

WM5005
1-1/8"

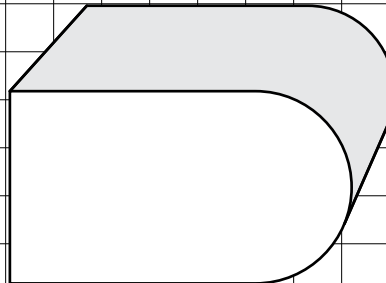

WM5007
1"

BULLNOSE

These knives are offered as a half-knife to be run as shown or a full knife which requires the stock to be run on its edge.

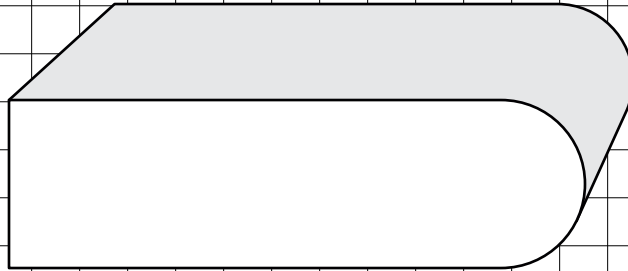

WM5008
7/8"

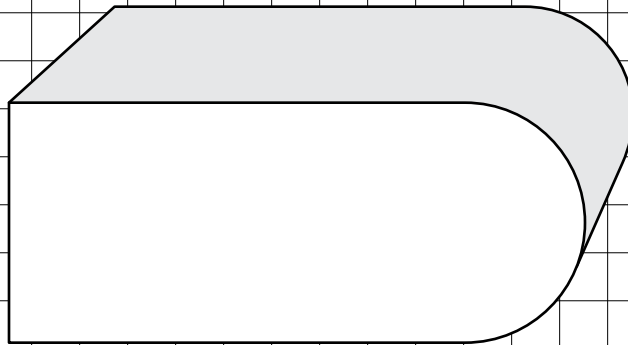

WM5009
1-1/4"

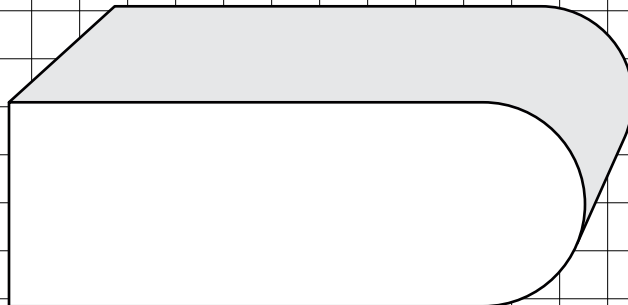

WM5010
1-1/16"

CABINET MOLDINGS

These moldings require a set of three knives for the top and for the bottom.

These knives require the use of a bedboard.

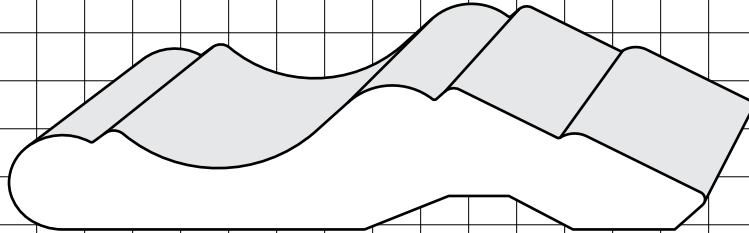

WM4100

3/4" X 3-5/8"

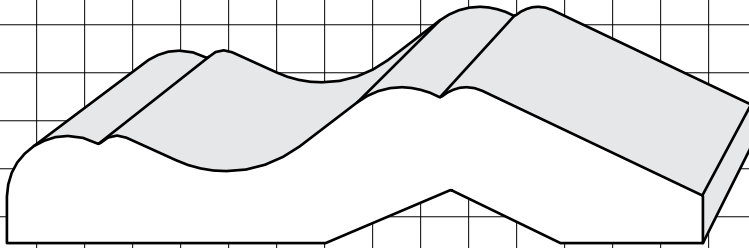

WM4101

3/4" X 3-5/8"

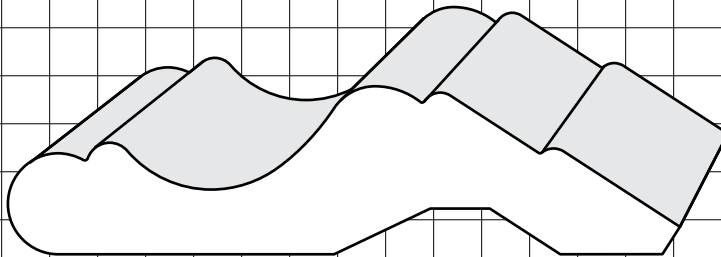

WM4102

7/8" X 3-1/2"

CASINGS

These moldings require a back relief knife.
Many of our casing knives are available as open-ended knives.

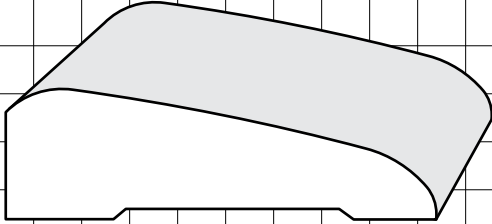

WM306
11/16" X 2-1/4"

This knife requires the use of a bedboard.

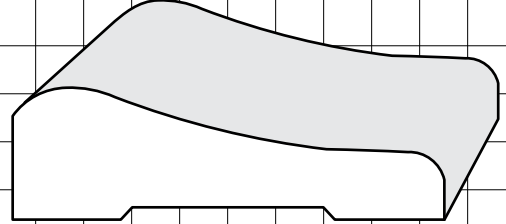

WM321
11/16" X 2-1/4"

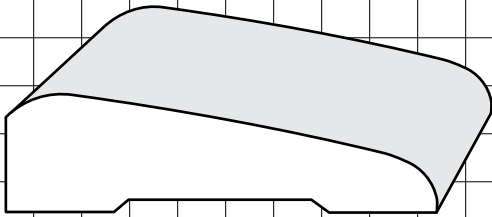

WM307
5/8" X 2-1/4"

This knife requires the use of a bedboard.

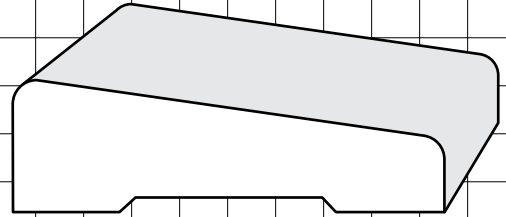

WM324
11/16" X 2-1/4"

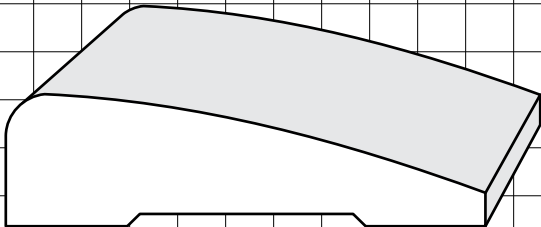

WM315
11/16" X 2-1/2"

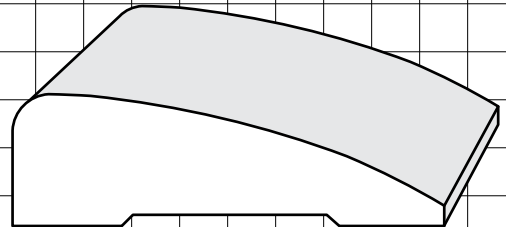

WM327
11/16" X 2-1/4"

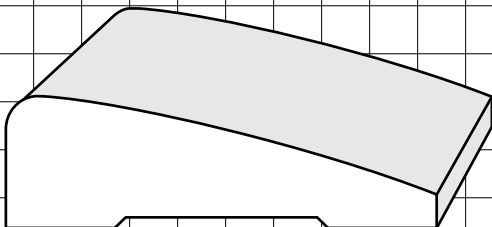

WM316
11/16" X 2-1/4"

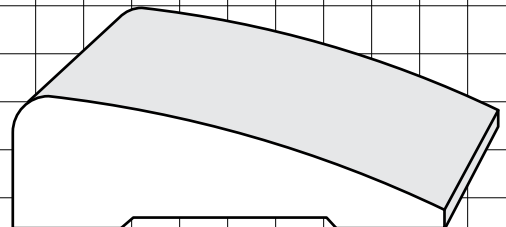

WM328
11/16" X 2-1/4"

CASINGS

These moldings require a back relief knife.
Many of our casing knives are available as open-ended knives.

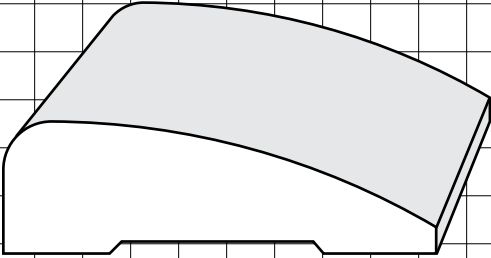

WM329
11/16" X 2-1/4"

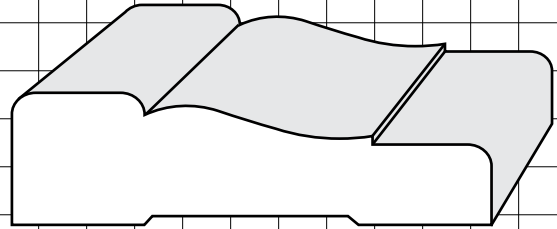

WM351
11/16" X 2-1/2"

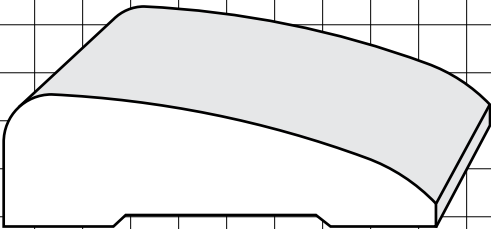

WM330
11/16" X 2-1/4"

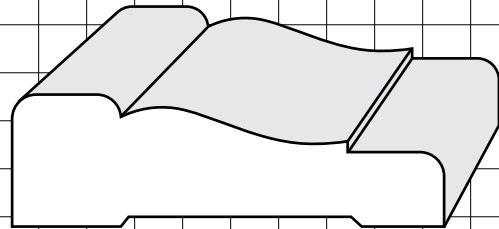

WM356
11/16" X 2-1/4"

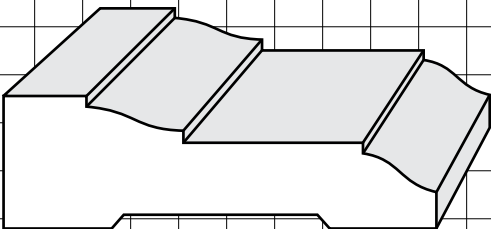

WM332
11/16" X 2-1/4"

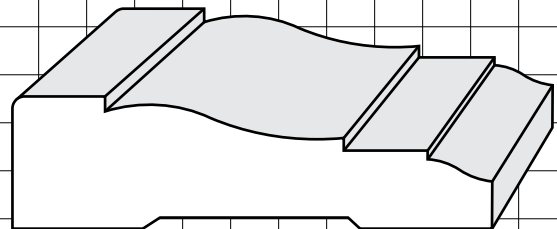

WM361
11/16" X 2-1/2"

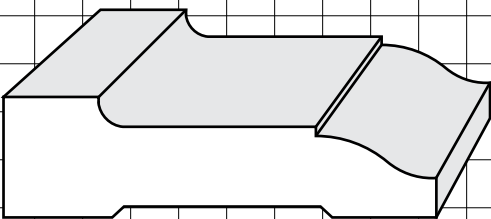

WM346
5/8" X 2-1/4"

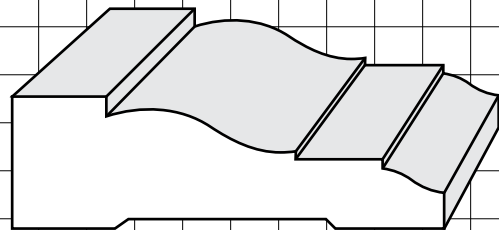

WM366
11/16" X 2-1/4"

CASINGS

These moldings require a back relief knife.
Many of our casing knives are available as open-ended knives.

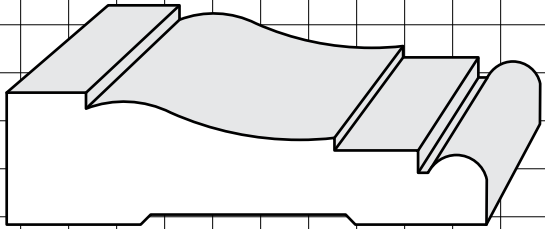

WM371
11/16" X 2-1/2"

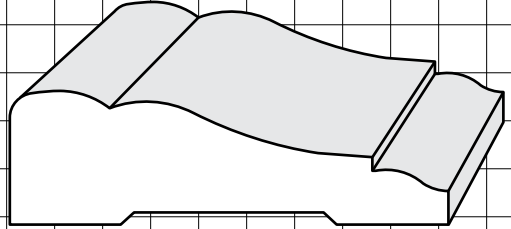

WM442
11/16" X 2-1/4"

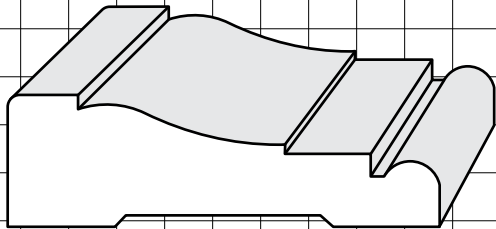

WM376
11/16" X 2-1/4"

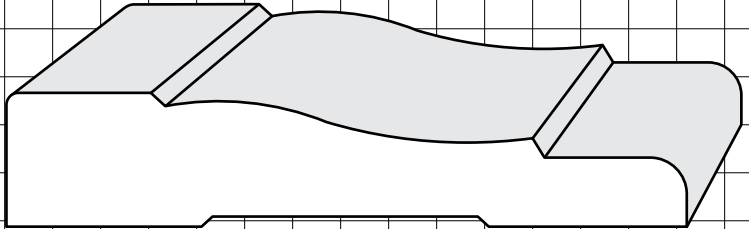

WM444
11/16" X 3-1/2"

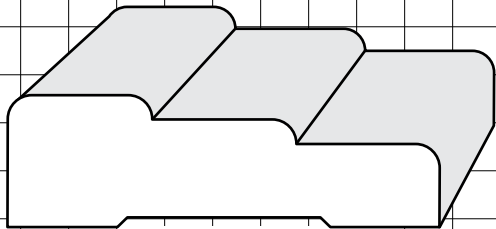

WM387
11/16" X 2-1/4"

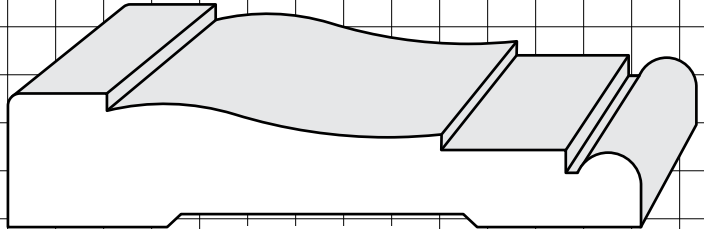

WM445
11/16" X 3-1/4"

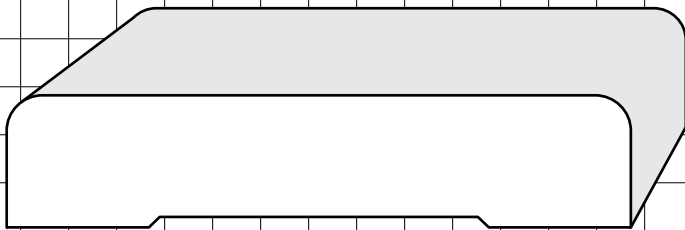

WM413
11/16" X 3-1/4"

This profile available in various widths.

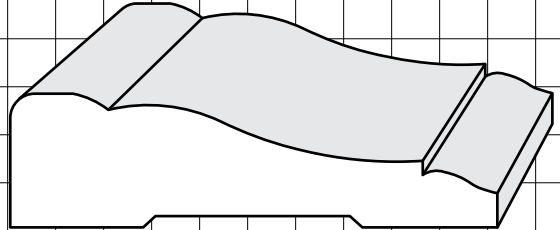

WM440
11/16" X 2-1/2"

CASINGS

These moldings require a back relief knife.
Many of our casing knives are available as open-ended knives.

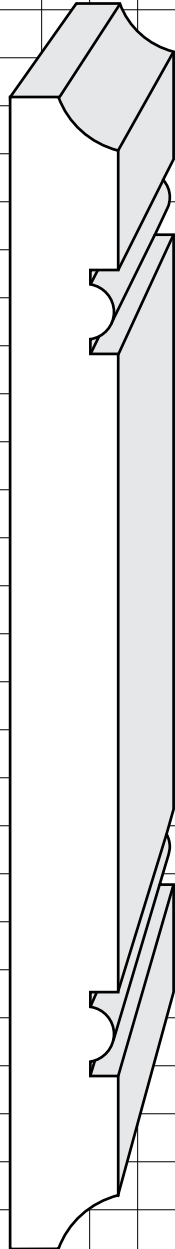

A46
9/16" X 6"

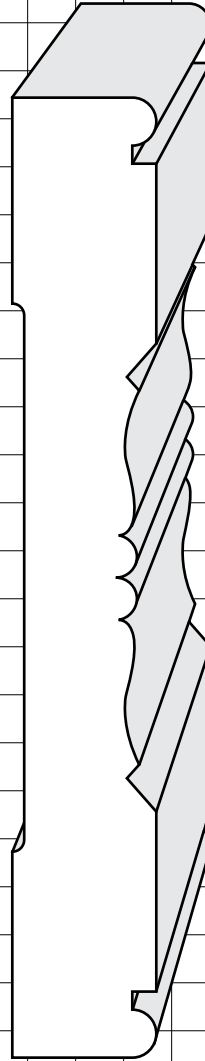

WM2001
3/4" X 5"

CASINGS

These moldings require a back relief knife.
Many of our casing knives are available as open-ended knives.

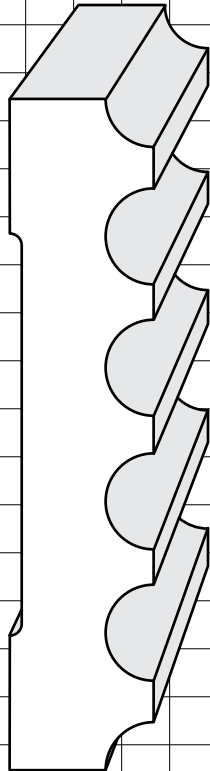

WM2004
3/4" X 3-1/2"

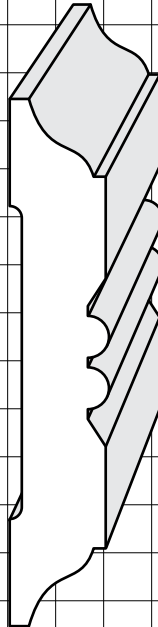

WM2005
1/2" X 2-3/4"



MK0047
3/4" X 3"

CASINGS

These moldings require a back relief knife.
Many of our casing knives are available as open-ended knives.

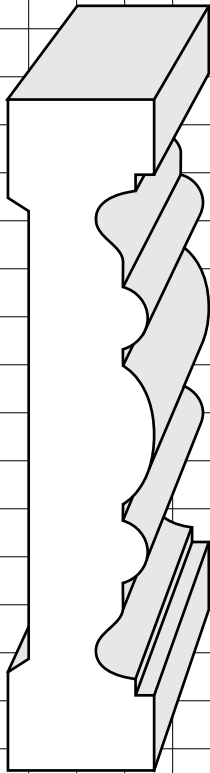

WM2006
3/4" X 3-1/2"

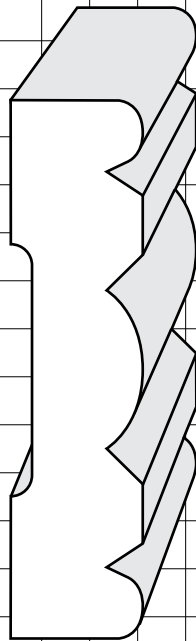

WM2007
11/16" X 2-13/16"

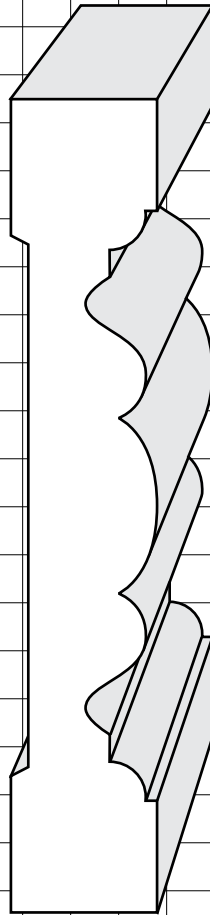

WM2008
3/4" X 4-1/4"

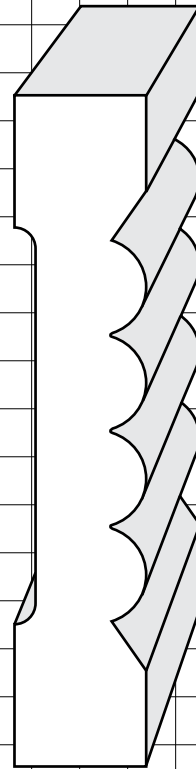

WM2009
11/16" X 3-1/2"

CASINGS

These moldings require a back relief knife.
Many of our casing knives are available as open-ended knives.

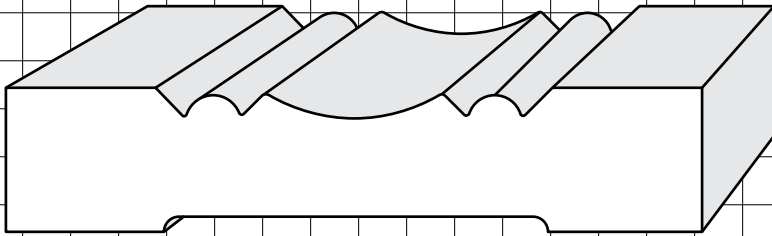

WM2010
3/4" X 3-5/8"

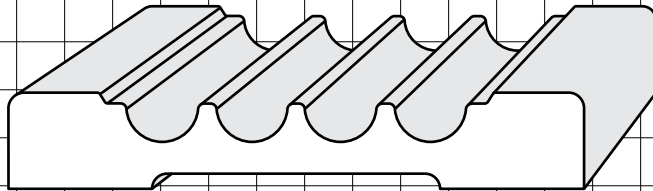

WM2011
1/2" X 3"

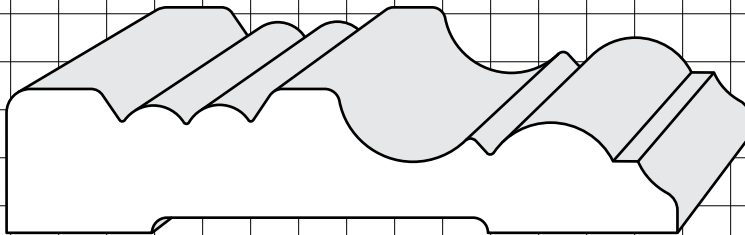

WM2012
3/4" X 3-1/2"

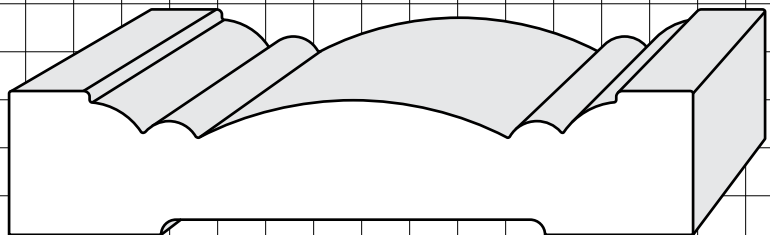

WM2013
3/4" X 3-9/16"

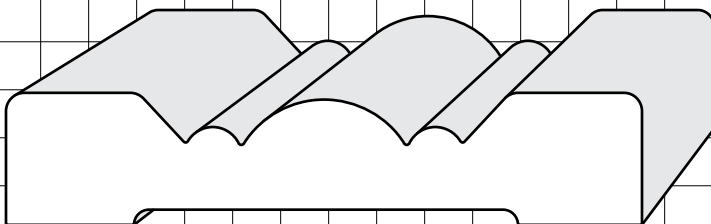

WM2014
5/8" X 3-5/16"

COLONIAL CASINGS

These moldings require a back relief knife.
Many of our casing knives are available as open-ended knives.

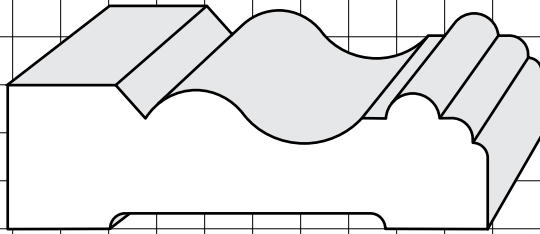

WM501
3/4" X 2-1/2"

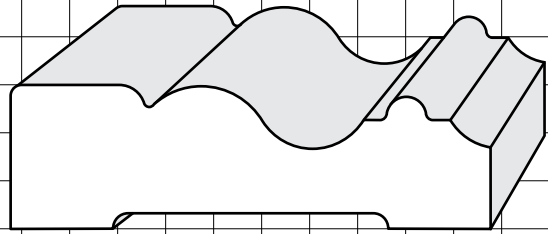

WM504
3/4" X 2-1/2"

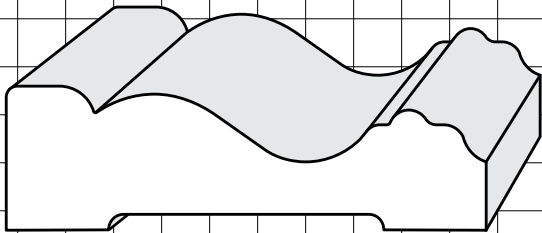

WM502
3/4" X 2-1/2"

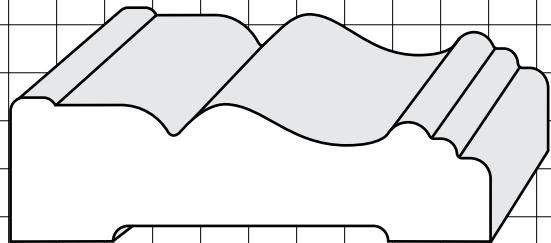

WM506
3/4" X 2-1/2"

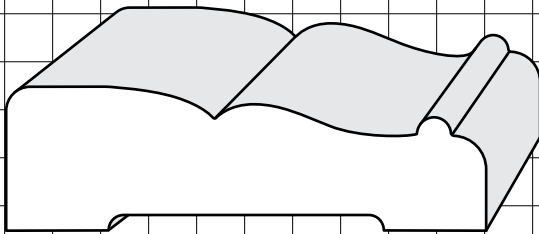

WM503
3/4" X 2-1/2"

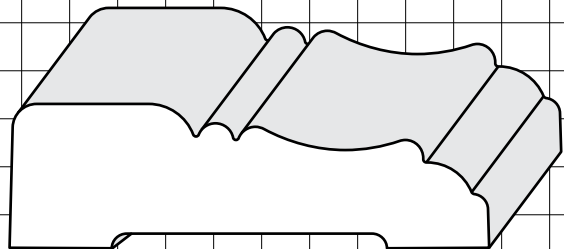

WM507
3/4" X 2-1/2"

COLONIAL CASINGS

These moldings require a back relief knife. Many casing knives are available as open-ended knives.

*These knives require the use of a bedboard.

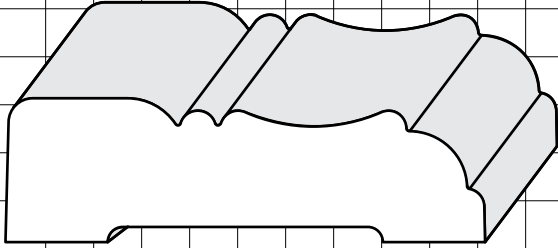

WM508
3/4" X 2-1/2"

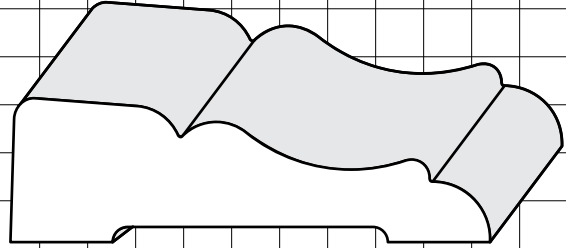

WM511*
3/4" X 2-1/2"

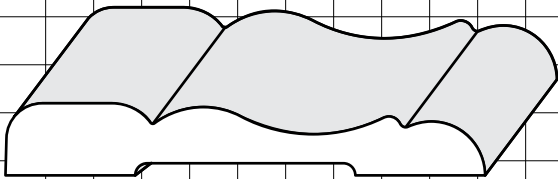

WM509*
3/8" X 2-1/2"

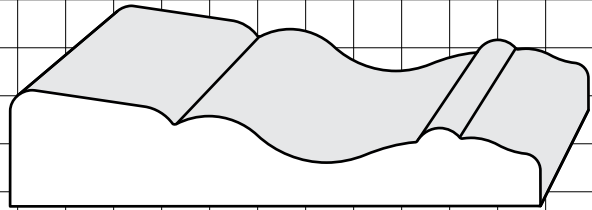

WM513
5/8" X 2-3/4"

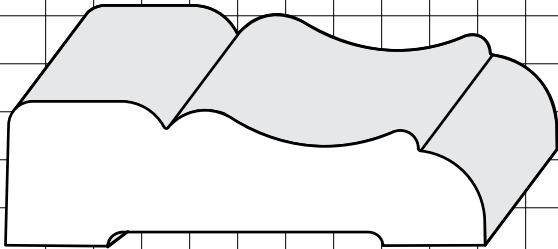

WM510*
3/4" X 2-1/2"

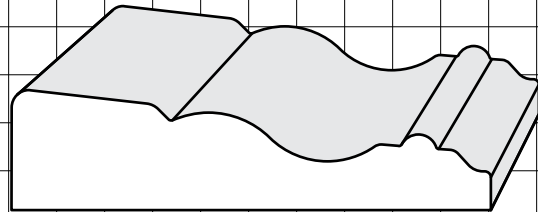

WM514
5/8" X 2-1/2"

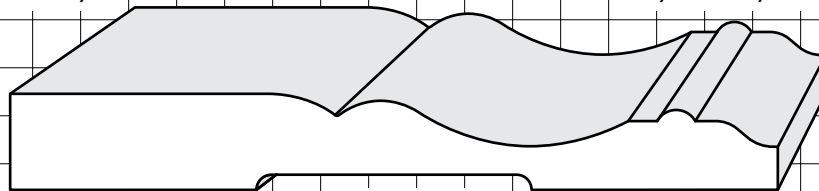

WM512
1/2" X 4"

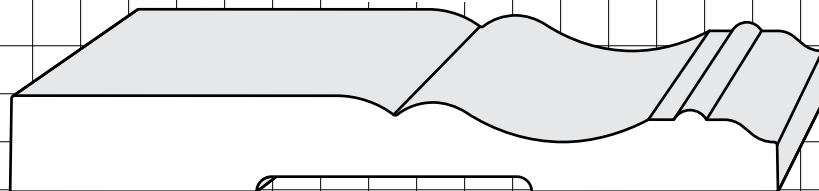

WM515
1/2" X 4"

CHAIR RAILS

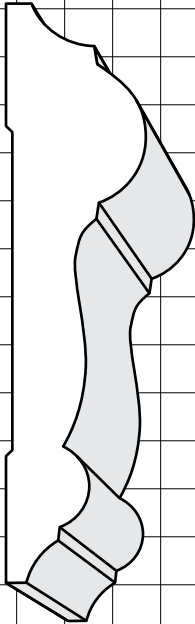

WM297
11/16" X 3"

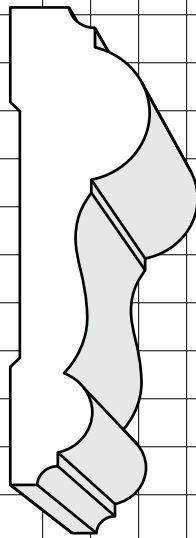

WM298
11/16" X 2-1/2"

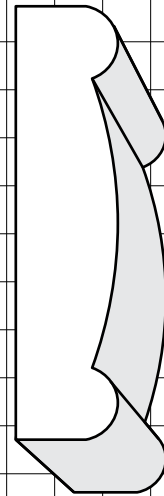

WM304
1/2" X 2-1/4"

COVES

These moldings require both a top and bottom knife.
These knives require the use of a bedboard.

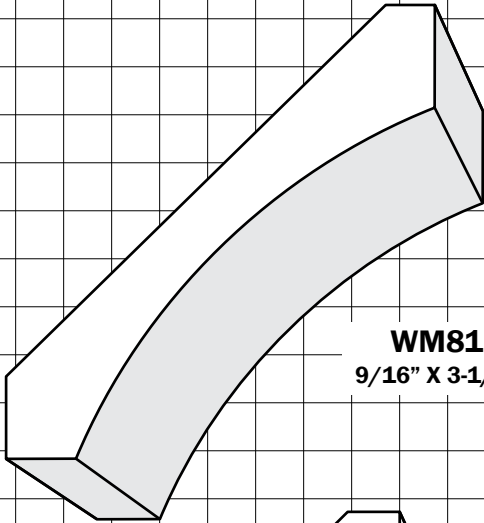

WM81
9/16" X 3-1/4"

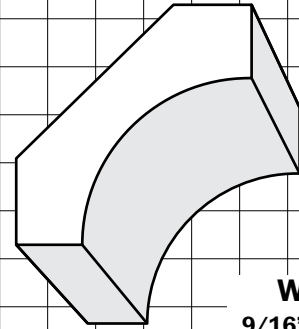

WM85
9/16" X 1-3/4"

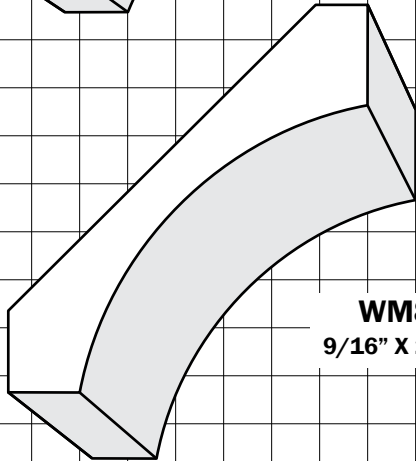

WM82
9/16" X 2-3/4"

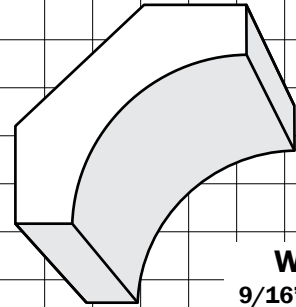

WM86
9/16" X 1-5/8"

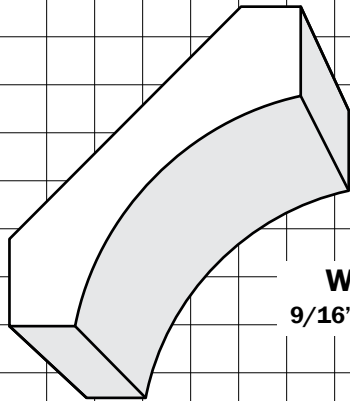

WM84
9/16" X 2-1/4"

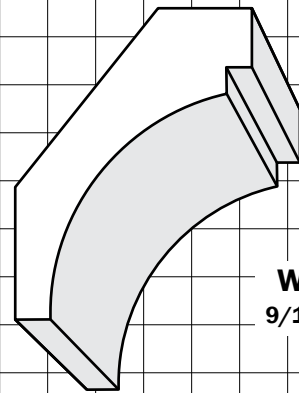

WM89
9/16" X 2"

COVES

Recommend using 2-up knife to accomplish these moldings.
These knives require the use of a bedboard.

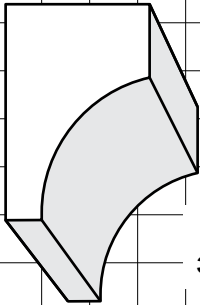

WM90
3/4" X 1-1/8"

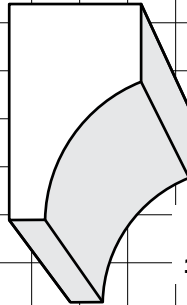

WM94
11/16" X 1-1/8"

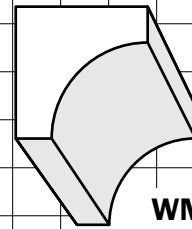

WM100
11/16" X 11/16"

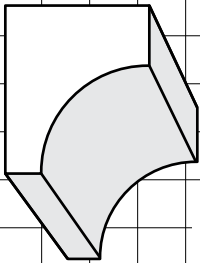

WM92
3/4" X 7/8"

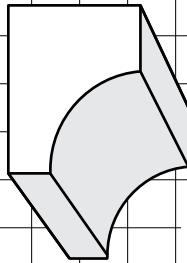

WM95
11/16" X 7/8"

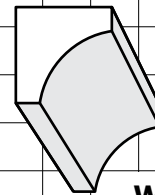

WM101
1/2" X 1/2"

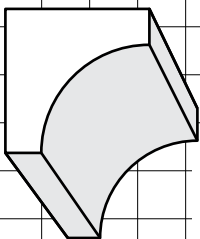

WM93
3/4" X 3/4"

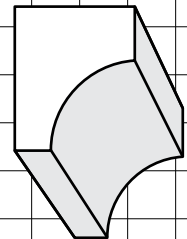

WM96
5/8" X 3/4"

CROWN MOLDING

Crown moldings require two separate passes to produce the finished pattern since the molding is cut on both top and bottom.

As illustrated in Fig. G pass one is for the bottom, and creates the bevelled side which mount against the wall and ceiling. After all stock has been passed through the bottom knife, pass two will create the top; the decorative profile that remains exposed to the eye once the molding has been mounted.

Fig. G

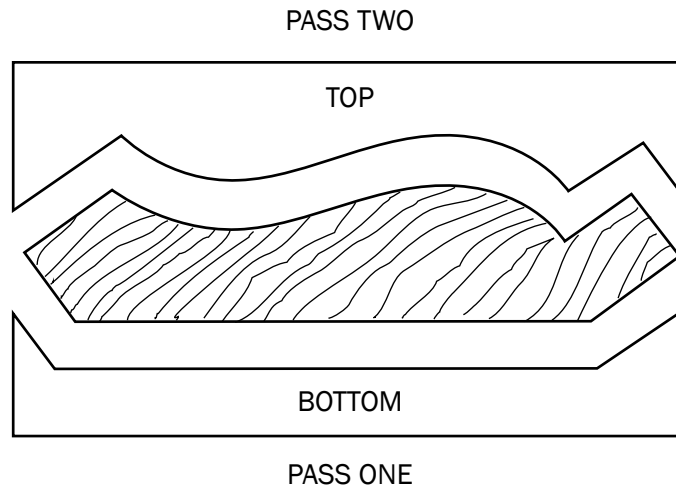

CROWN MOLDINGS

Split knife sets for the angle cut on crown moldings offer an affordable alternative for those short runs. Available in two different angle configurations and single or double-sided.

These knives require the use of a bedboard.

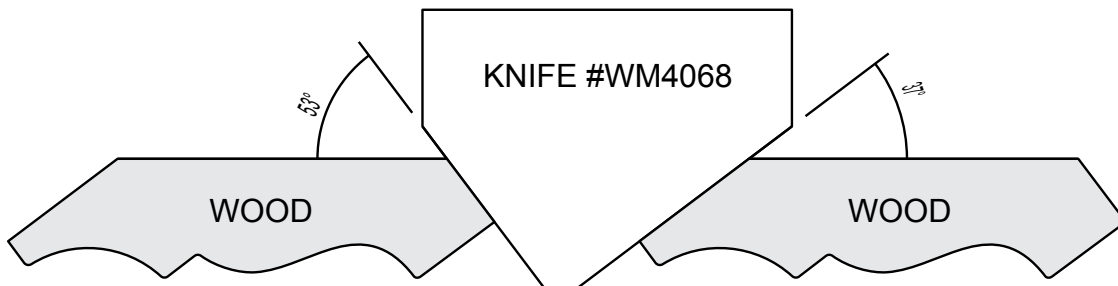
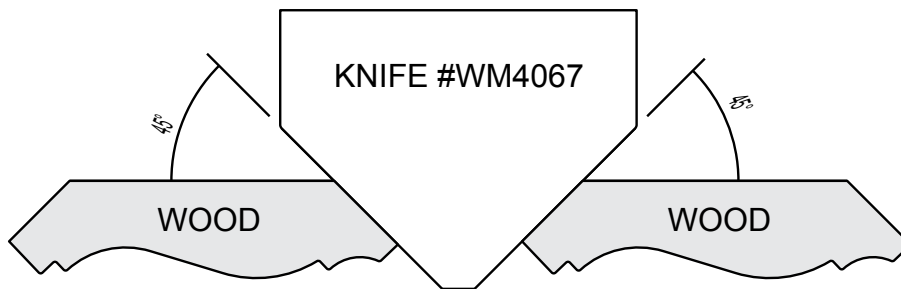
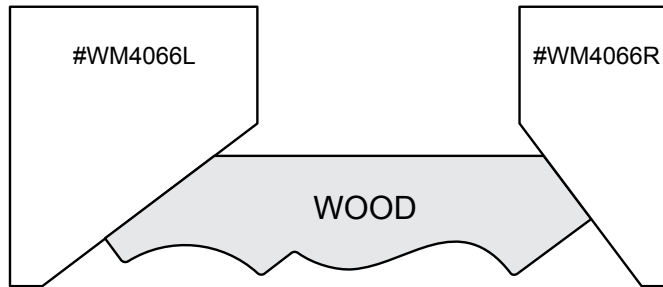
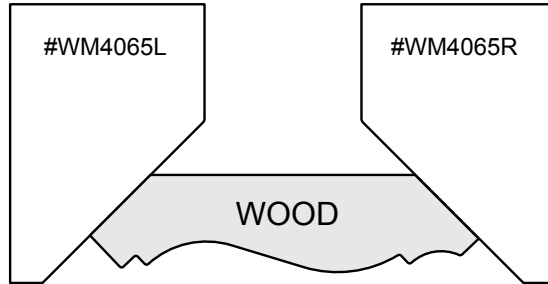

CROWN MOLDINGS

These moldings require both a top and bottom knife.
These knives require the use of a bedboard.

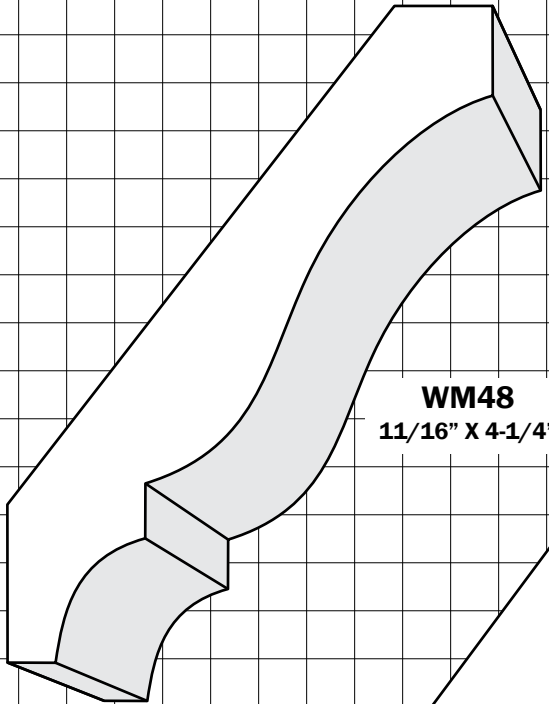

WM48
11/16" X 4-1/4"

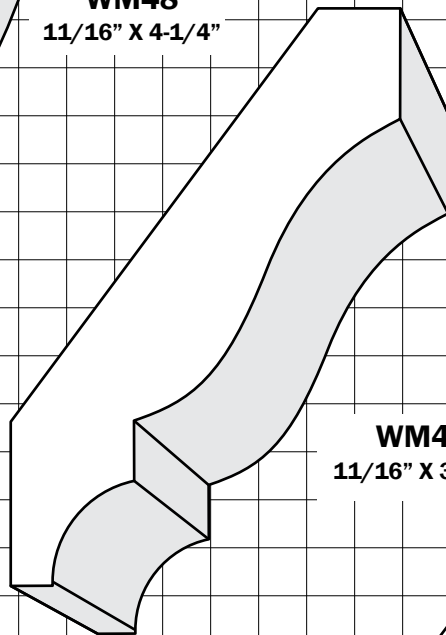

WM49
11/16" X 3-5/8"

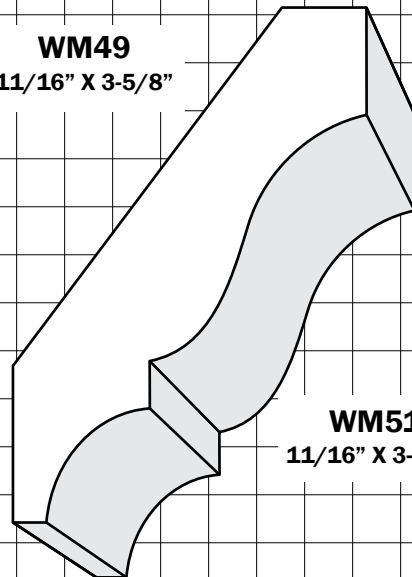

WM51
11/16" X 3-1/4"

CROWN MOLDINGS

These moldings require both a top and bottom knife.
These knives require the use of a bedboard.

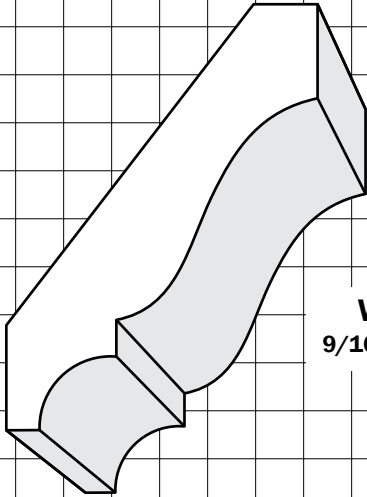

WM52
9/16" X 2-3/4"

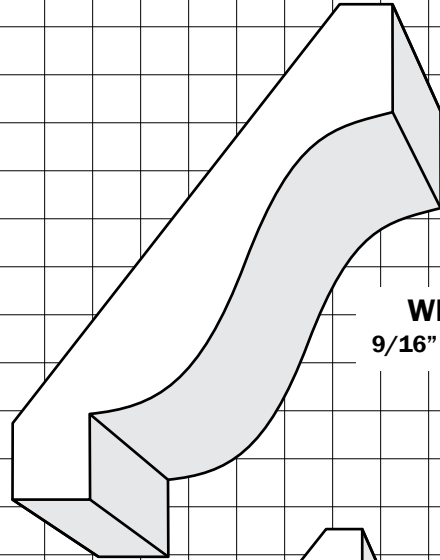

WM57
9/16" X 3-1/4"

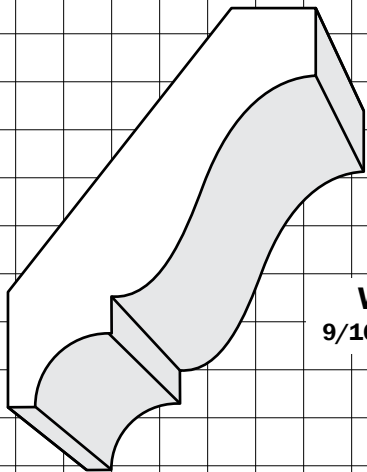

WM53
9/16" X 2-5/8"

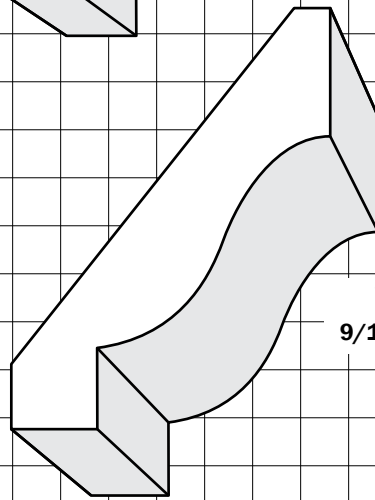

WM58
9/16" X 2-3/4"

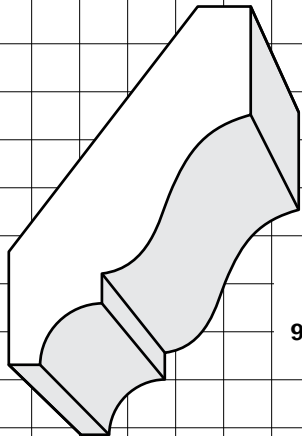

WM54
9/16" X 2-1/4"

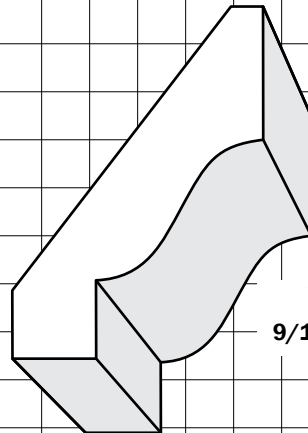

WM59
9/16" X 2-1/4"

CROWN MOLDINGS

These moldings require both a top and bottom knife.
These knives require the use of a bedboard.

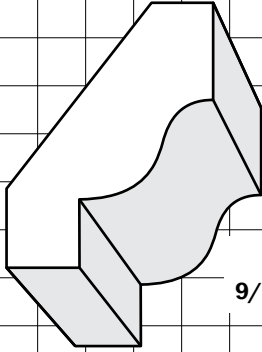

WM60
9/16" X 1-3/4"

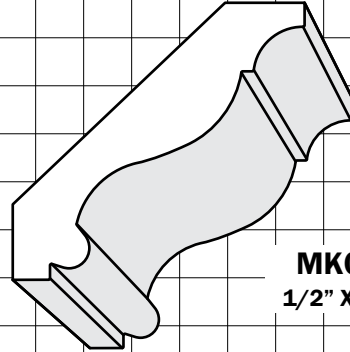

MK0044
1/2" X 2-1/8"

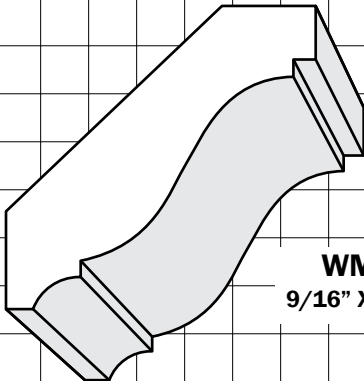

WM67
9/16" X 2-1/4"

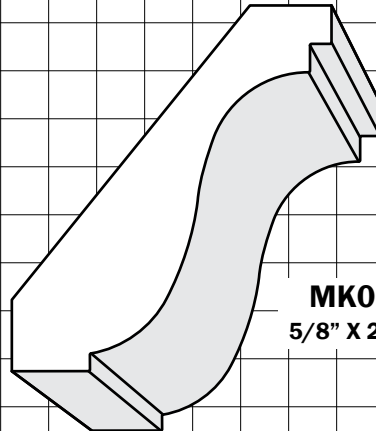

MK0045
5/8" X 2-9/16"

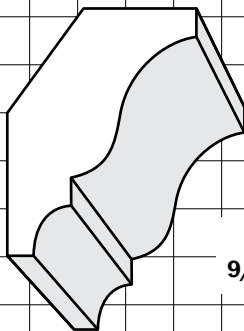

WM68
9/16" X 1-5/8"

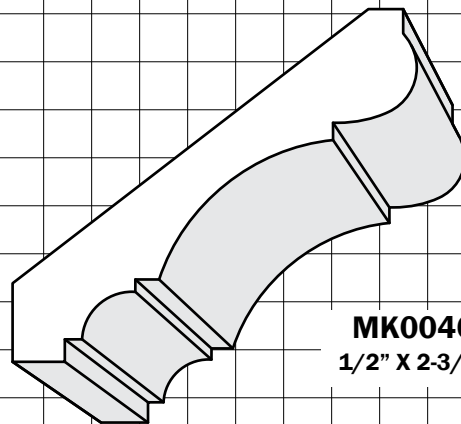

MK0046
1/2" X 2-3/4"

CROWN MOLDINGS

These moldings require both a top and bottom knife.
These knives require the use of a bedboard.

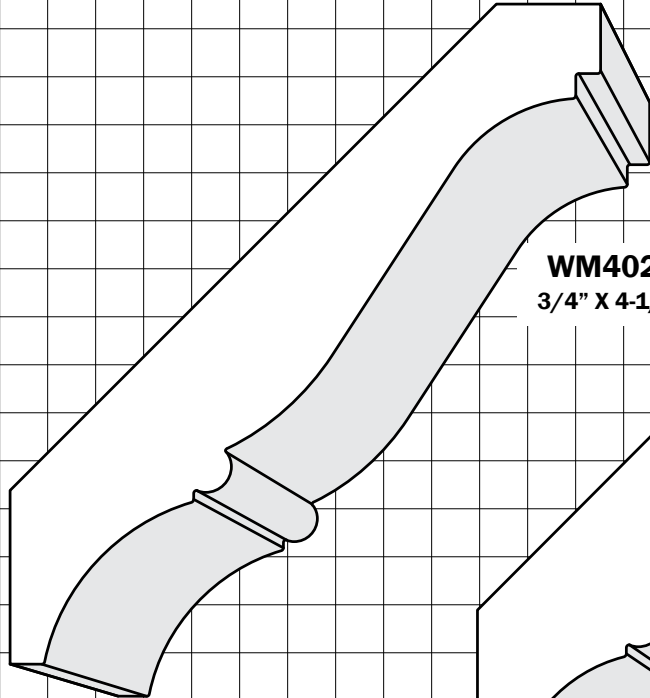

WM4026
3/4" X 4-1/2"

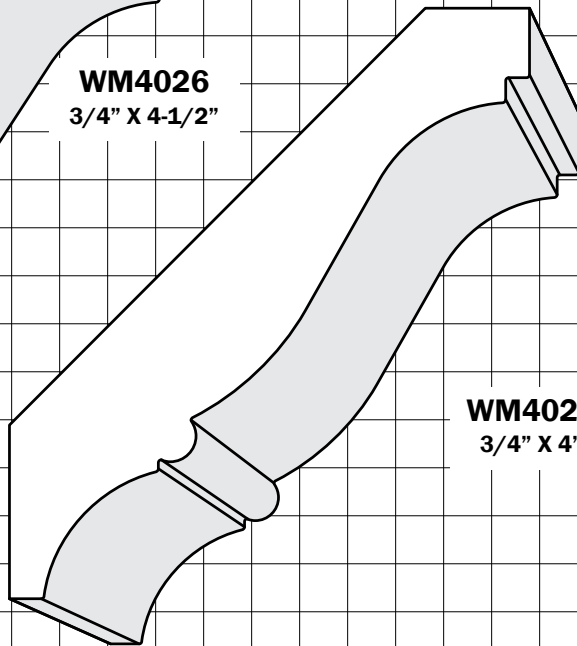

WM4027
3/4" X 4"

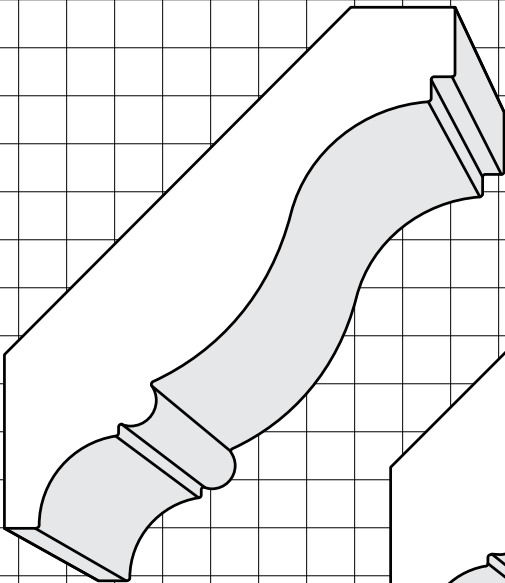

WM4028
3/4" X 3-1/2"

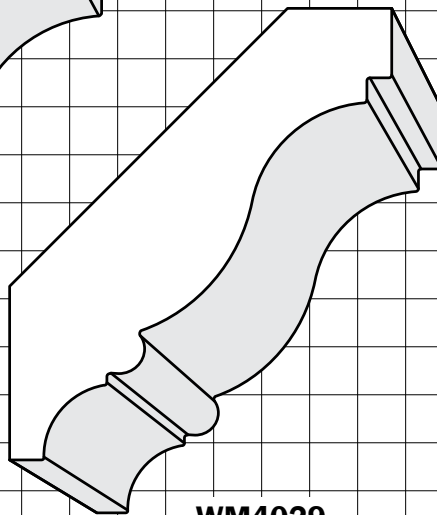

WM4029
3/4" X 3"

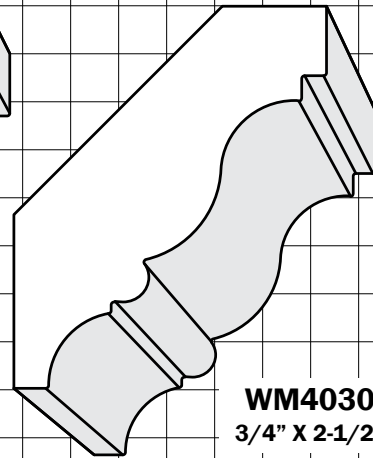

WM4030
3/4" X 2-1/2"

CROWN MOLDINGS

These moldings require both a top and bottom knife.
These knives require the use of a bedboard.

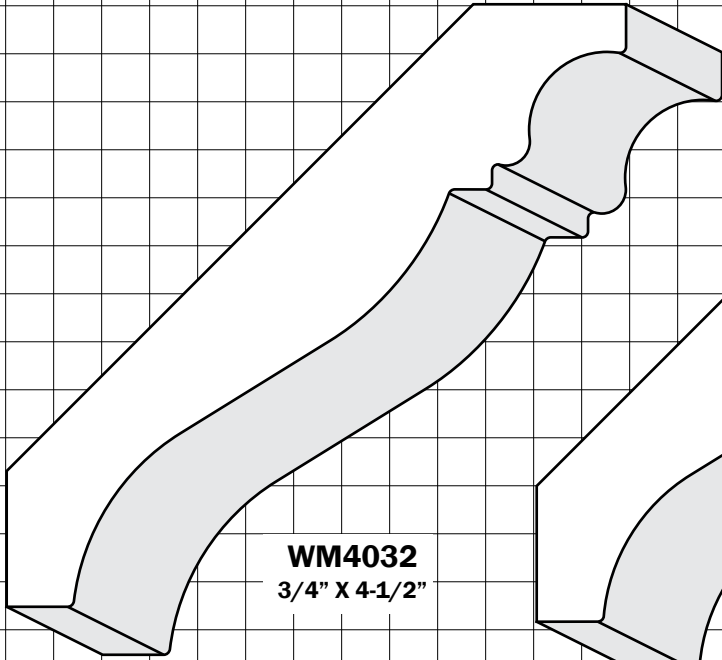

WM4032
3/4" X 4-1/2"

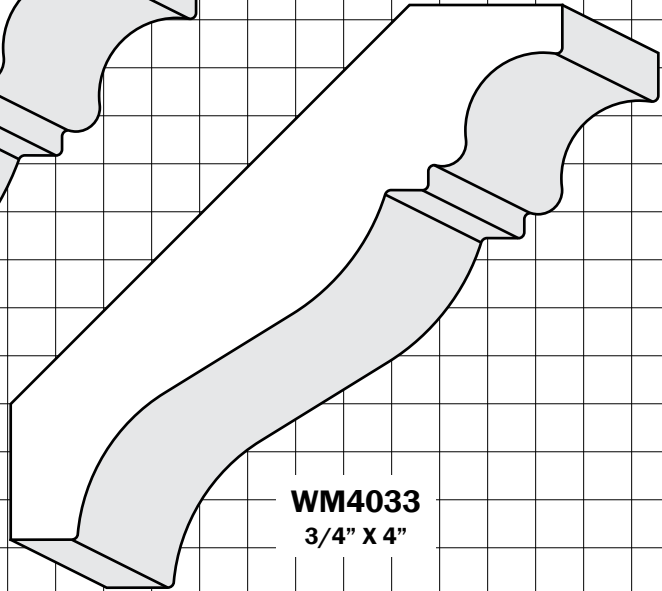

WM4033
3/4" X 4"

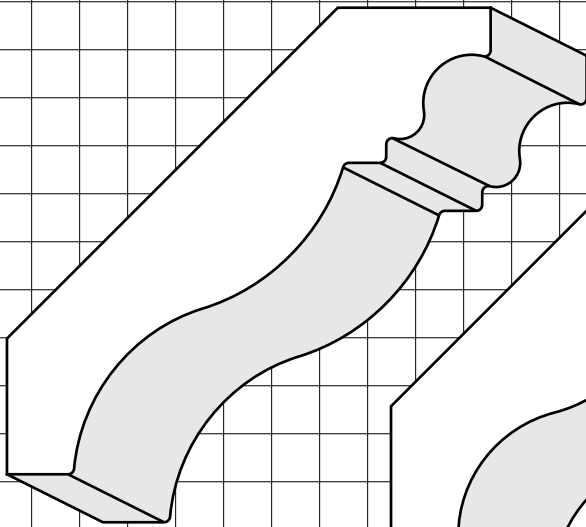

WM4034
3/4" X 3-1/2"

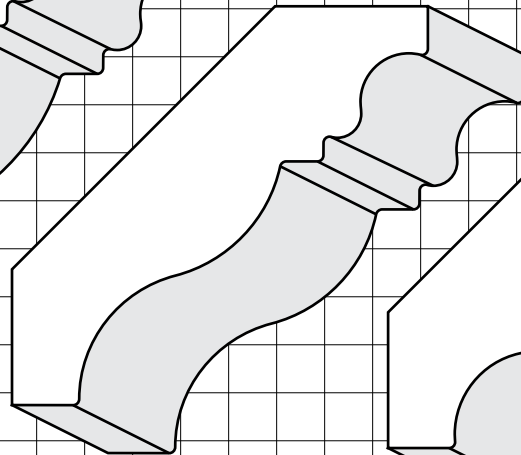

WM4035
3/4" X 3"

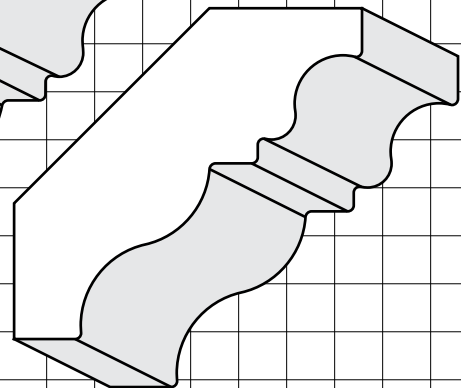

WM4036
3/4" X 2-1/2"

CROWN MOLDINGS

These moldings require both a top and bottom knife.
— These knives require the use of a bedboard.

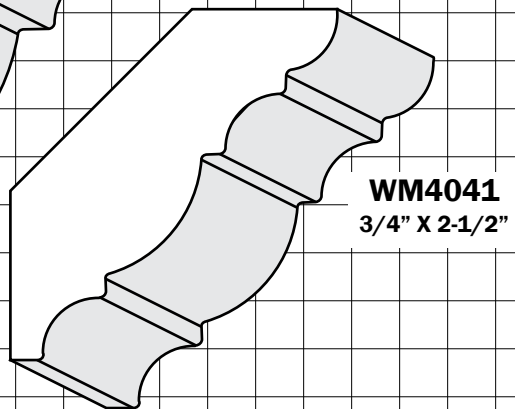
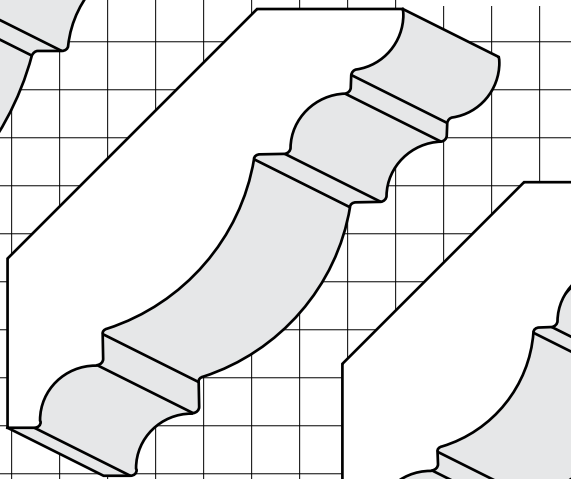
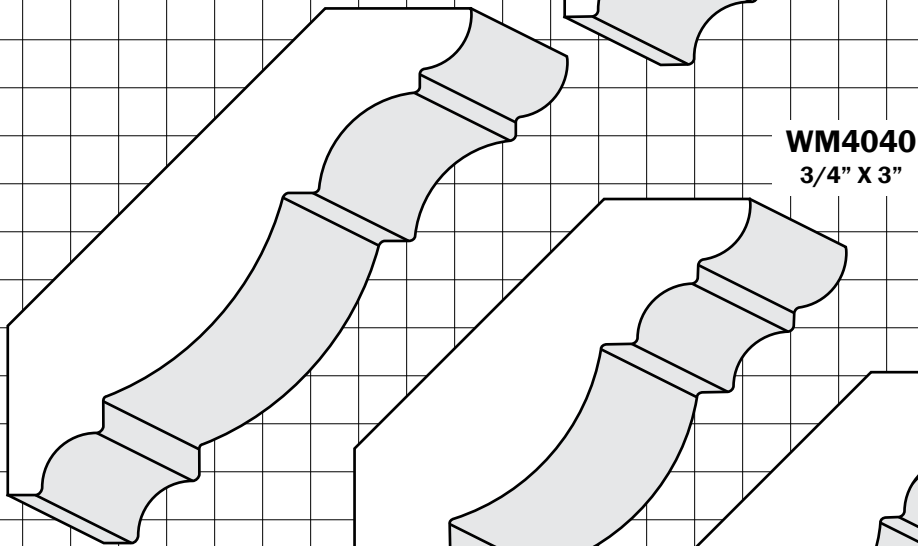
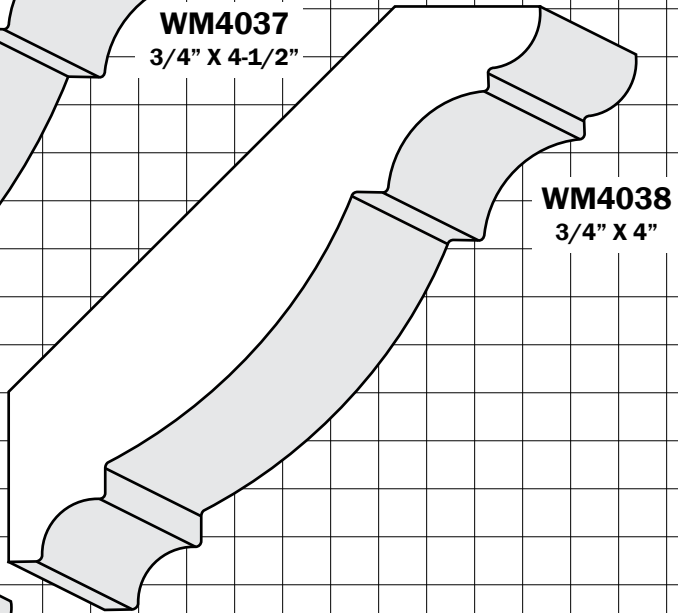
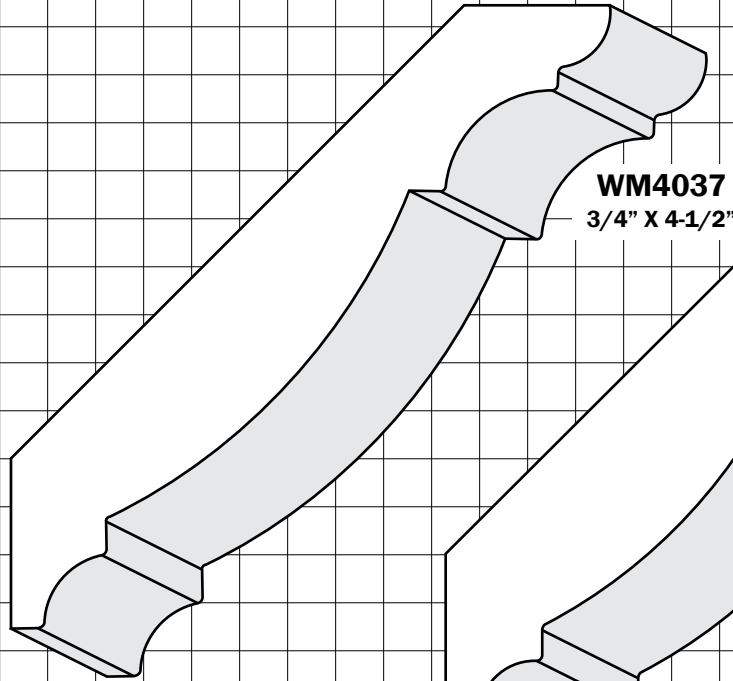

WM4039
3/4" X 3-1/2"

WM4041
3/4" X 2-1/2"

CROWN MOLDINGS

These moldings require both a top and bottom knife.
— These knives require the use of a bedboard.

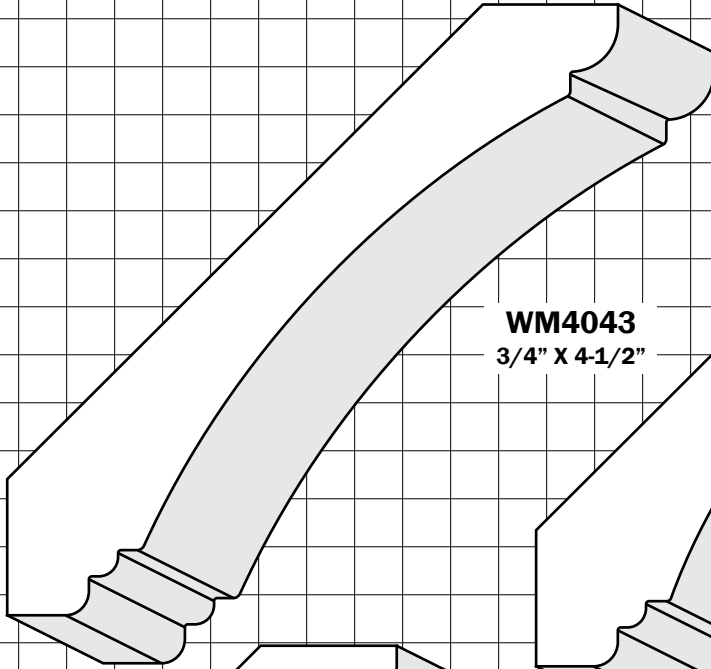

WM4043
3/4" X 4-1/2"

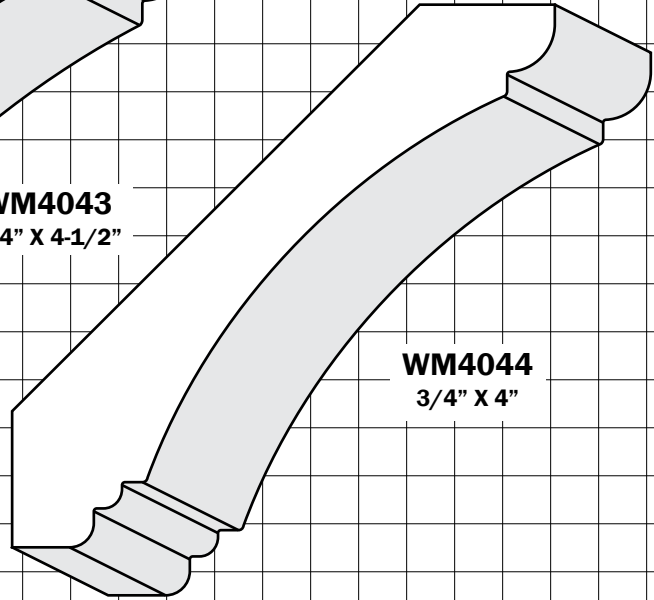

WM4044
3/4" X 4"

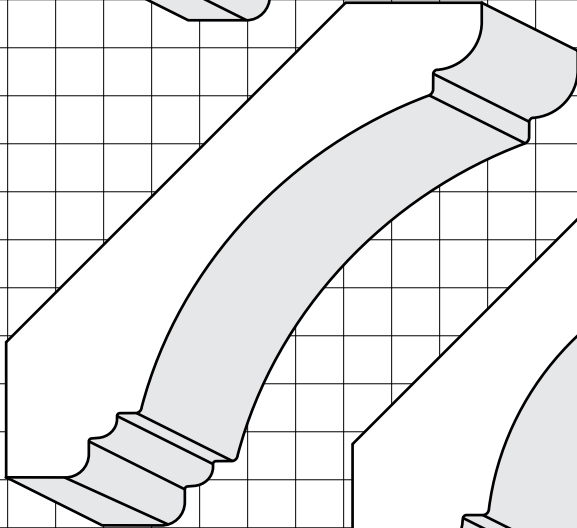

WM4045
3/4" X 3-1/2"

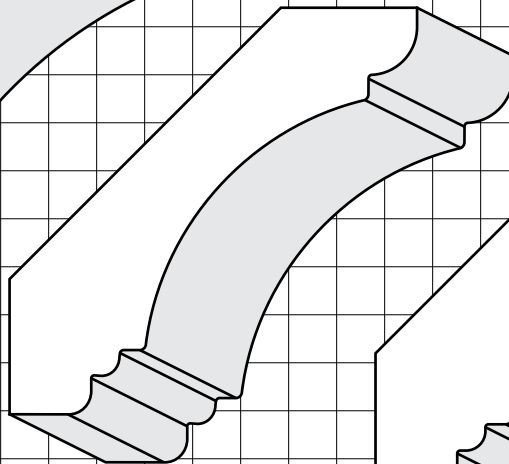

WM4046
3/4" X 3"

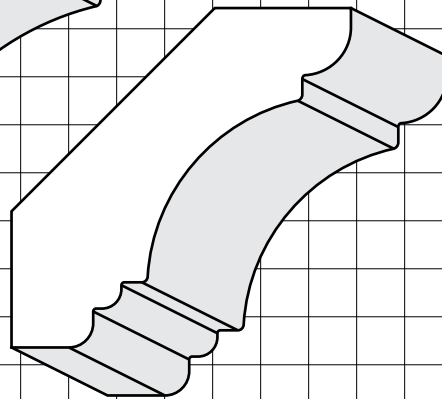

WM4047
3/4" X 2-1/2"

CROWN MOLDINGS

These moldings require both a top and bottom knife.
These knives require the use of a bedboard.

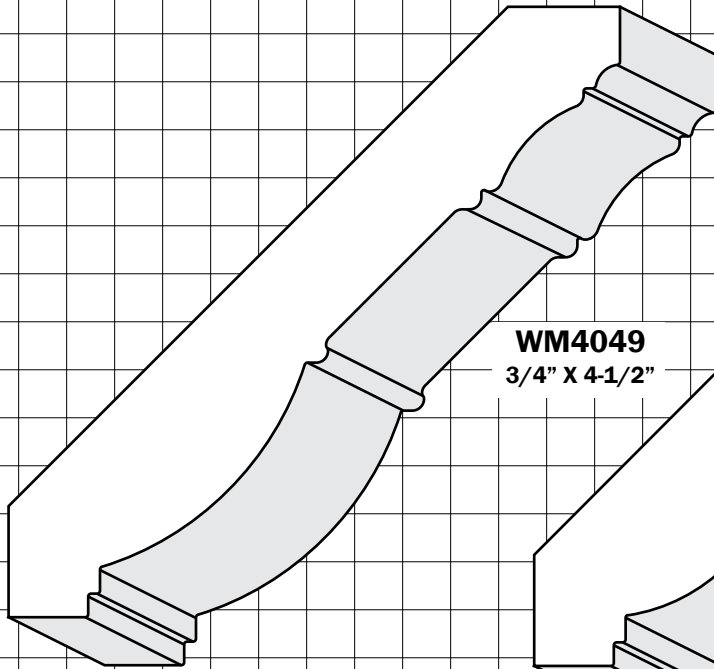

WM4049
3/4" X 4-1/2"

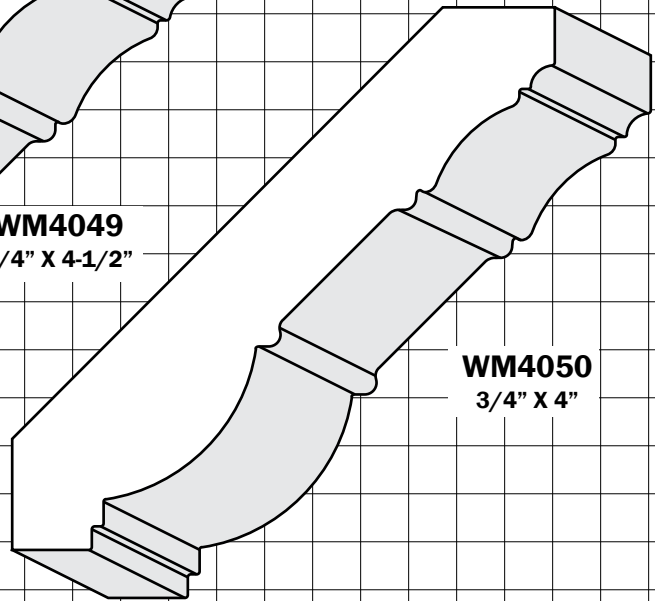

WM4050
3/4" X 4"

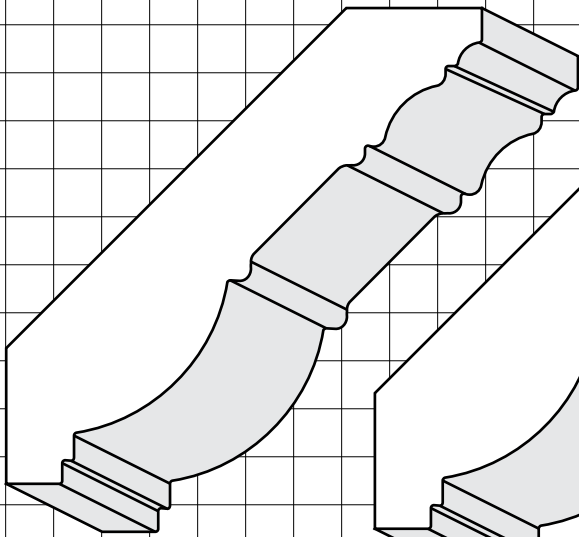

WM4051
3/4" X 3-1/2"

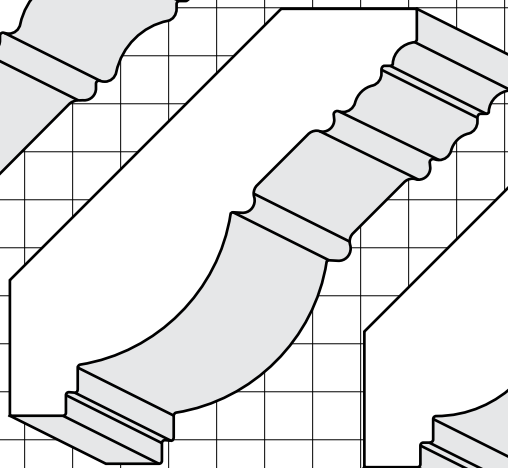

WM4052
3/4" X 3"

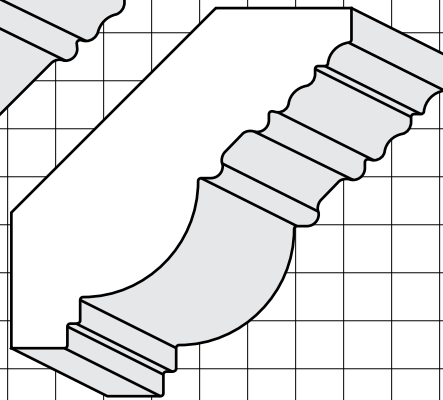

WM4053
3/4" X 2-1/2"

CROWN MOLDINGS

These moldings require both a top and bottom knife.
These knives require the use of a bedboard.

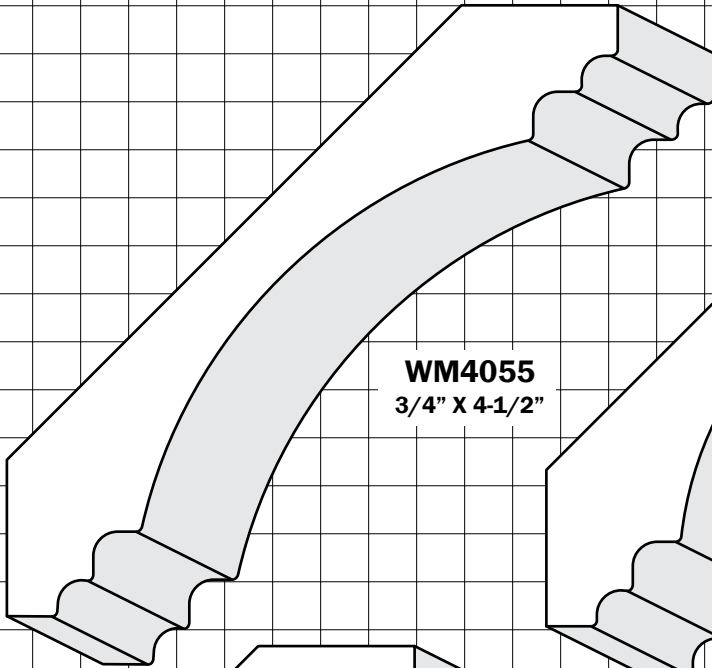

WM4055
3/4" X 4-1/2"

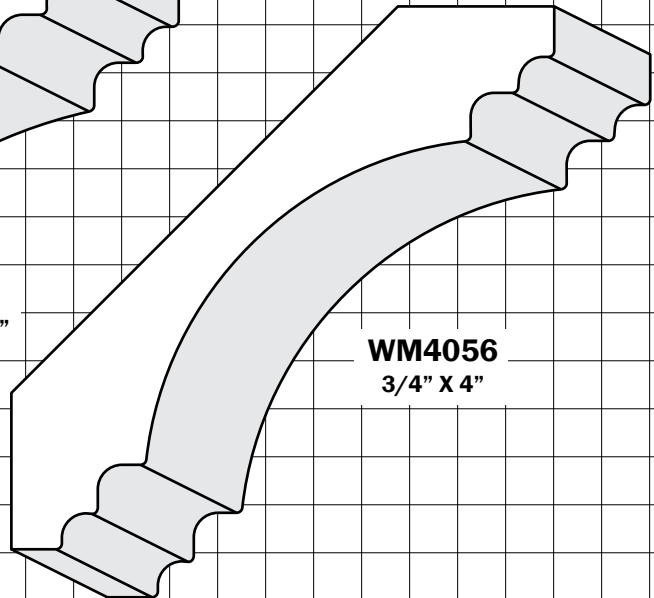

WM4056
3/4" X 4"

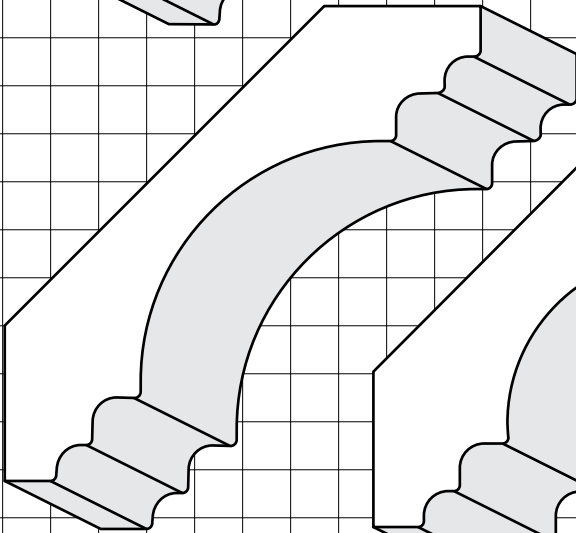

WM4057
3/4" X 3-1/2"

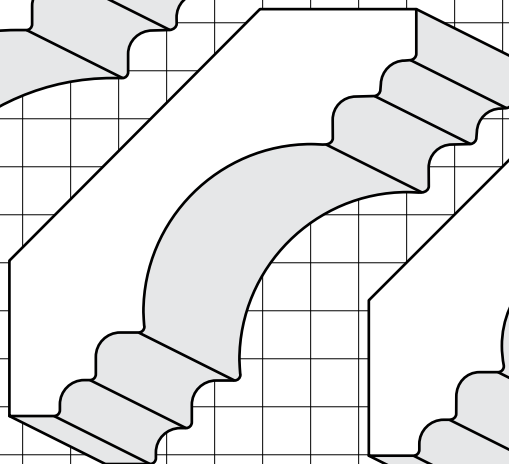

WM4058
3/4" X 3"

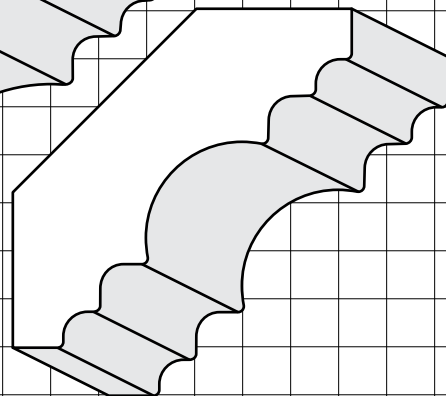

WM4059
3/4" X 2-1/2"

CROWN MOLDINGS

These moldings require both a top and bottom knife.
These knives require the use of a bedboard.

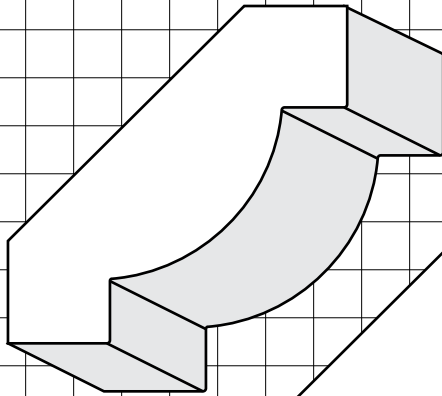

WM4060
3/4" X 2-1/2"

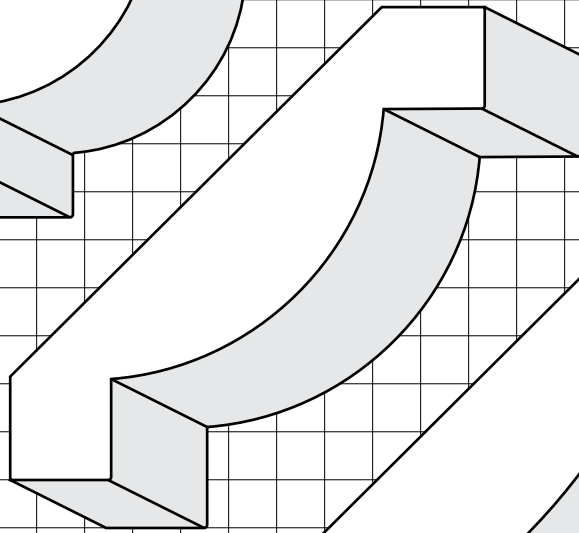

WM4061
3/4" X 3-1/2"

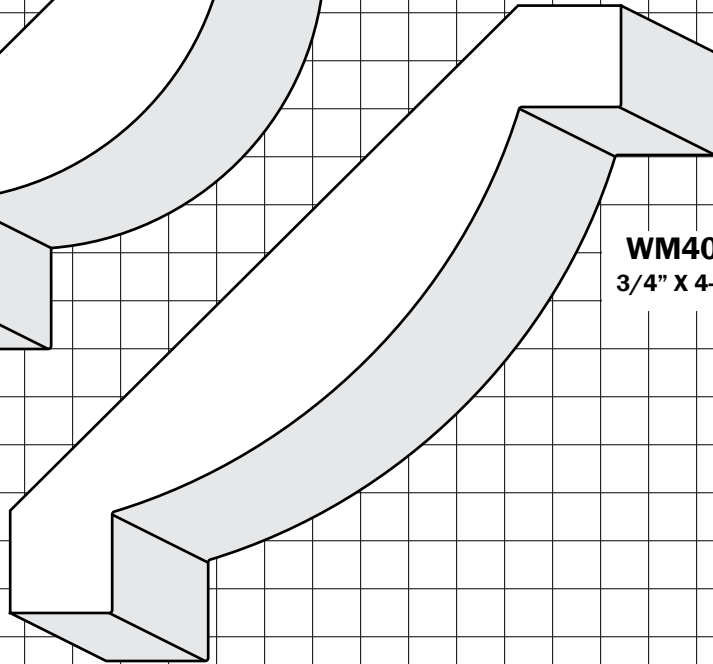

WM4062
3/4" X 4-1/2"

CROWN MOLDINGS

These moldings require both a top and bottom knife.
These knives require the use of a bedboard.

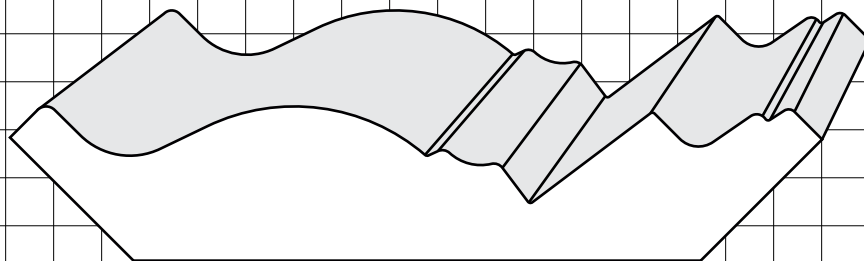

MK0843

13/16" X 4-1/4"

Insert for rope or dentil molding

CURVES

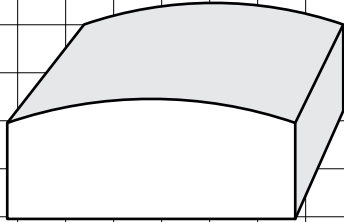

MK0900
5/8" X 1-1/2"

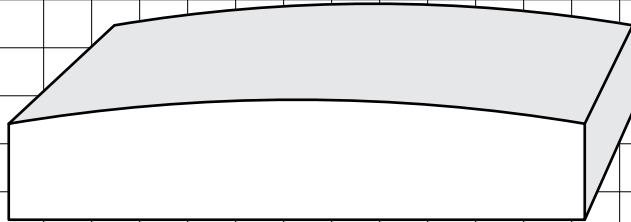

MK0903
5/8" X 3"

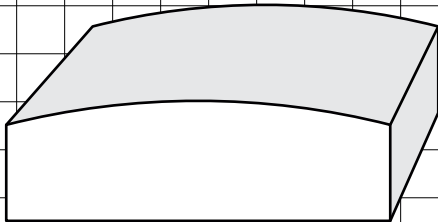

MK0901
5/8" X 2"

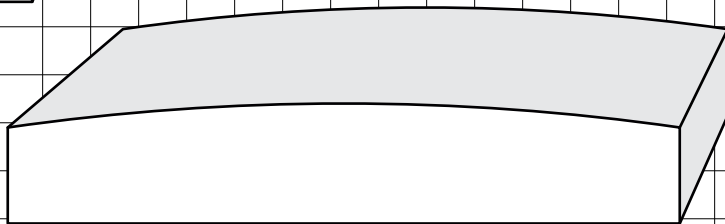

MK0904
5/8" X 3-1/2"

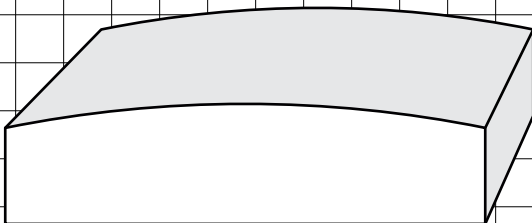

MK0902
5/8" X 2-1/2"

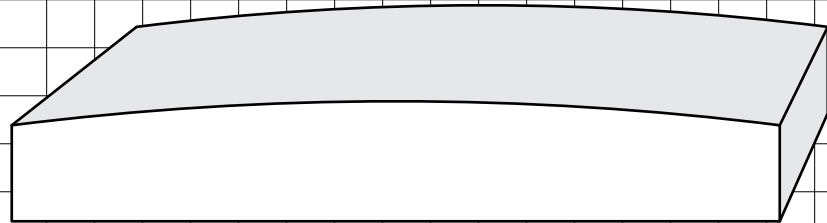

MK0905
5/8" X 4"

CURVES

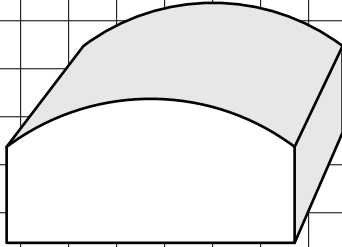

MK0906
3/4" X 1-1/2"

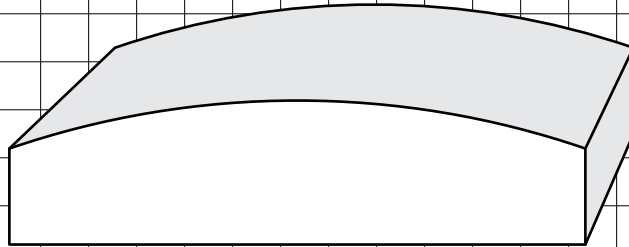

MK0909
3/4" X 3"

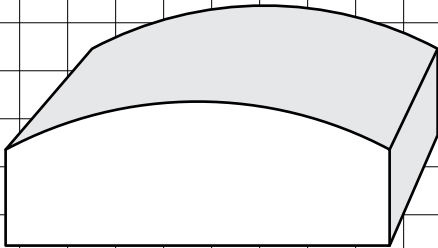

MK0907
3/4" X 2"

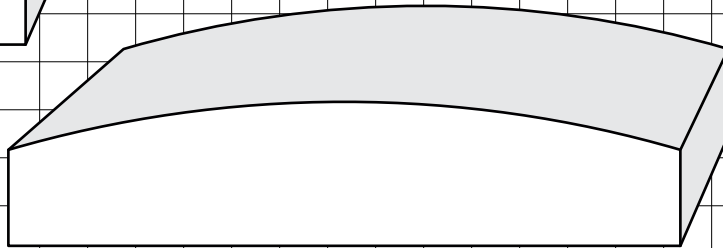

MK0910
3/4" X 3-1/2"

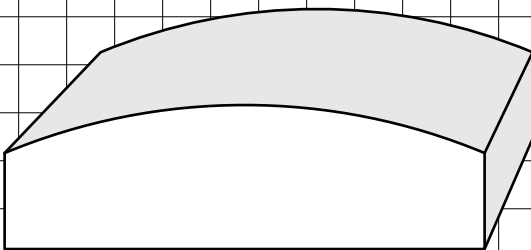

MK0908
3/4" X 2-1/2"

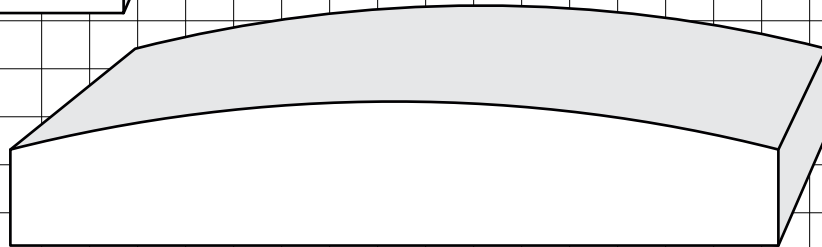

MK0911
3/4" X 4"

DESIGNER KNIFE SERIES

Shown below area some of the many profiles you can create using our new Designer Knife series. You are only limited by your imagination.

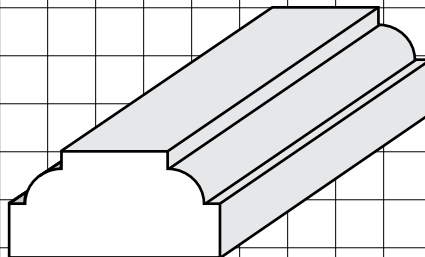
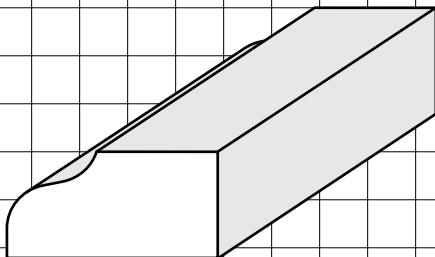
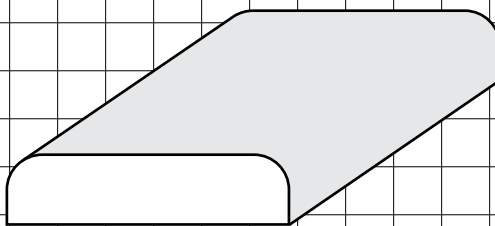
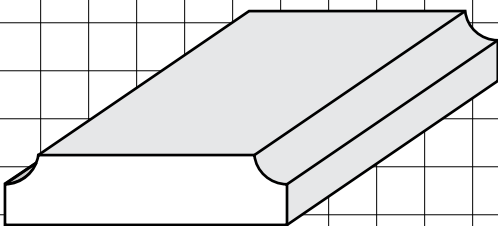
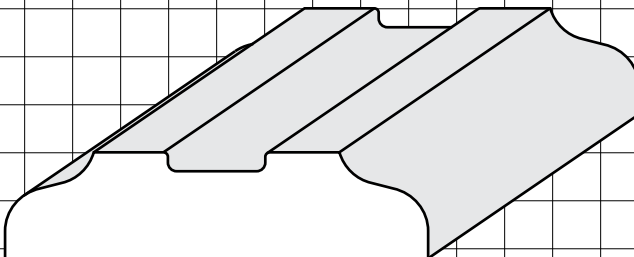
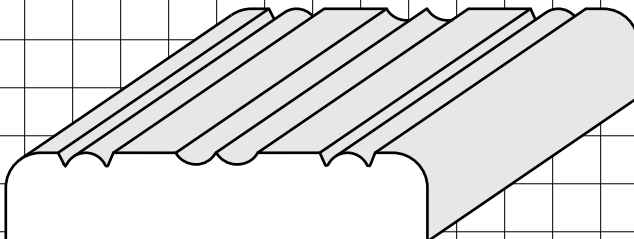

DESIGNER KNIFE SERIES

Shown below area some of the many profiles you can create using our new Designer Knife series. You are only limited by your imagination.

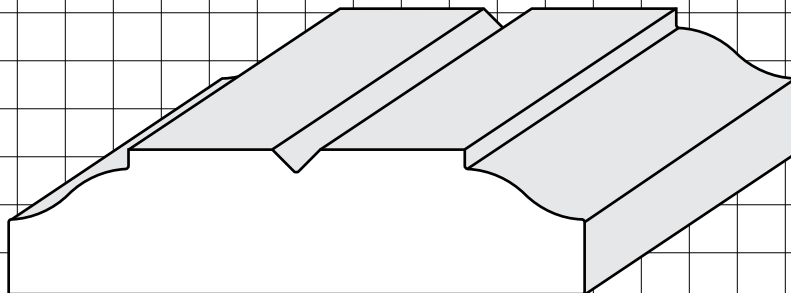
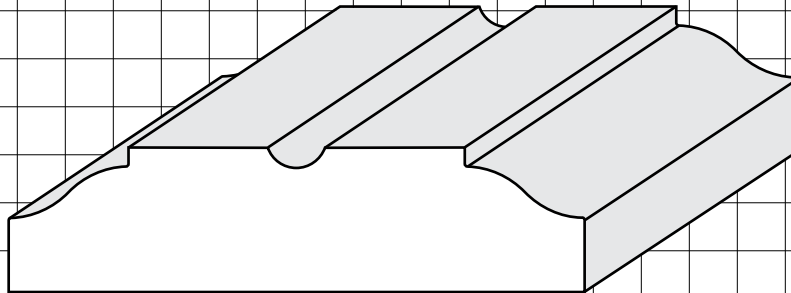
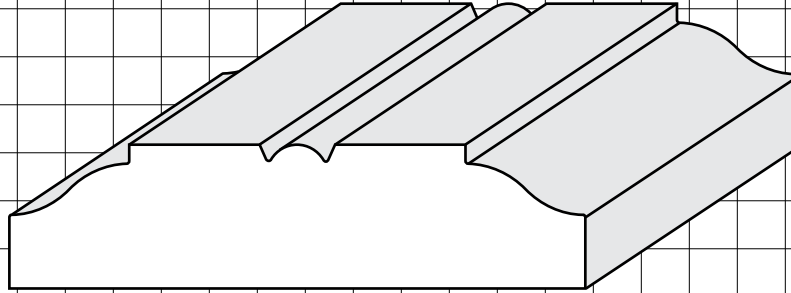
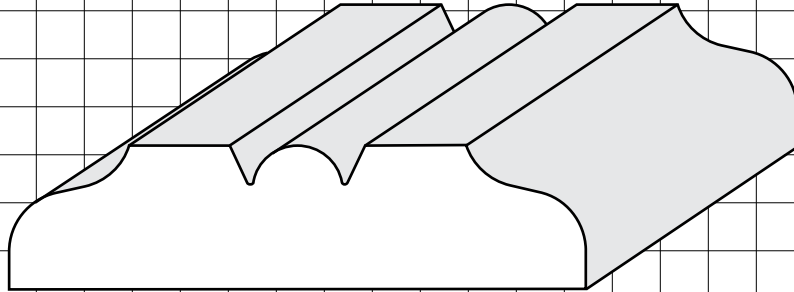

DESIGNER KNIFE SERIES

All knives below are shown at actual size.

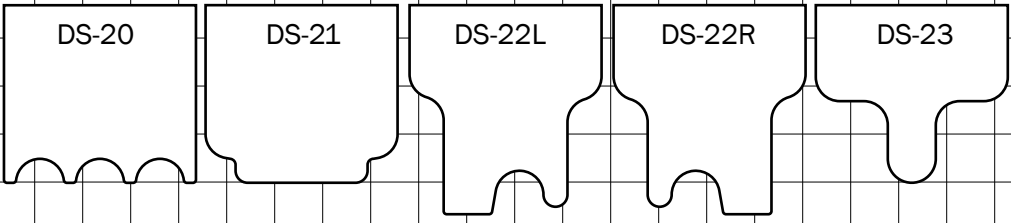
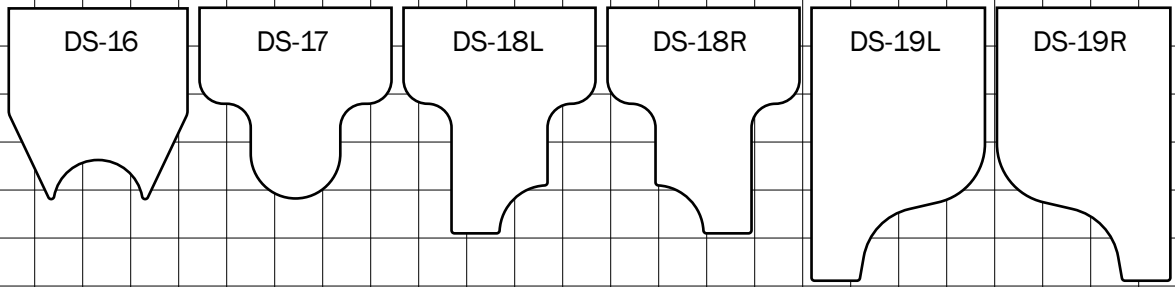
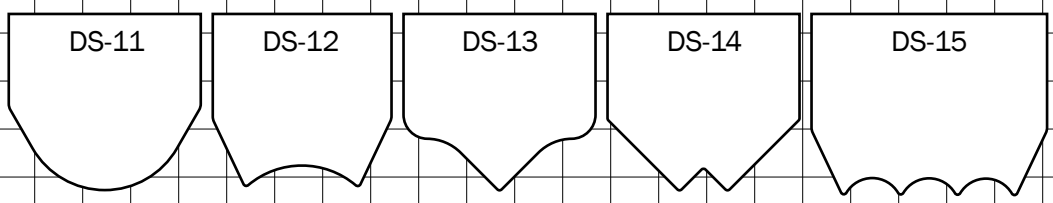
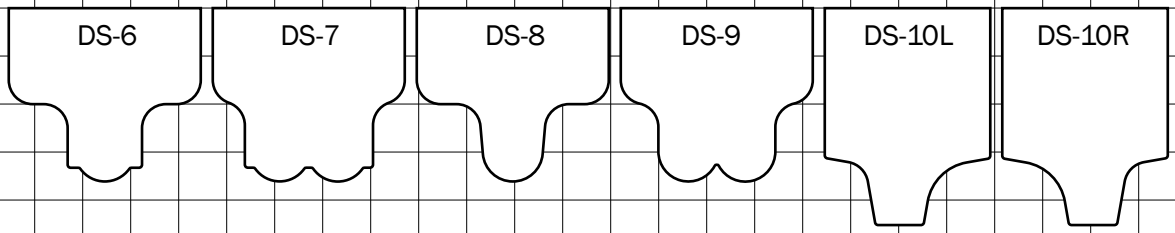
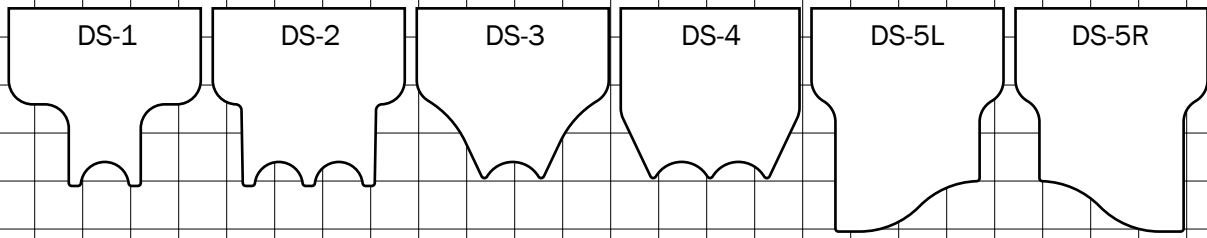

DOWELLING KNIVES

Standard sizes in dowelling are usually readily available in birch or maple from building supply stores. BUT what happens when you need a dowel for the walnut furniture you have just finished? Where do you find dowelling to finish that set of butternut kitchen cabinets for that very special customer? Perhaps you need dowelling that is that special size; where do you find it? Now YOU CAN MAKE PERFECT DOWELLING on your single-head planer / molder, RIGHT IN YOU OWN SHOP and chances are you can machine the dowelling from the off-cuts; those pieces you were going to burn!

Manufacturing dowelling with your single-head planer / molder is a very simple operation. We recommend that you use a single 2-up knife in the custom knife holder for dowelling from 5/16" up to 1" (Dowelling smaller than 5/16" is difficult to machine because the wood is so flimsy) and a matched set of three knives in the planer head for dowelling sizes from 1" to 2-1/4". When manufacturing dowelling, two passes are required to accomplish the finished dowel accurately.

The advantages of using a 2-up knife will be obvious the first time you use it. The 2-up knife will mold two identical pieces of dowelling (top or bottom) with each pass. The molding blank is much more stable and you will double your production.

LET'S MAKE DOWELLING:

For our sample we will use a WM121 2-up knife to make two pieces of 3/4" dowel.

1. Prepare the molding blanks from CLEAN, KILN-DRIED wood. The blank should measure 1-15/16" wide and 13/16" thick. It is very important that all blanks be exactly the same width to ensure that they are snugly held by the guides as the dowelling is being machined. Make a few extra blanks to use as test pieces.
2. Center the knife in the custom knife holder and tighten the gib screws to 5 foot pounds. (This can easily be done with a torque wrench).
3. Position the bedboard guides so the blank fits snugly when fed through them. Make sure the guides are at exact right angles with the accessory shaft.
4. Position the custom knife holder so the knife is centered on the molding blank. Tighten the knife holder to the accessory shaft.
5. Set the depth of cut to cut the full profile plus 1/32". When adjustment is correct, machine all blanks on one side. Keep you blanks butted end to end to avoid tear-out.
6. Turn blanks end for end and adjust depth of cut to make a perfectly round dowel. Remember to keep blanks butted.

HINTS

Feed stock slowly, especially when starting and finished the cut. You can increase feed speed to match the dowel size and the wood species when the blank is in contact with the outfeed rollers. Stop your machine, disconnect the power and retighten the gib after machining the first blank.

A WELCOME ADDITION

The most critical part of machining dowelling is to ensure that the blank is centered in relationship to the knife on the second pass. The simplest way of doing this is to make up a guide insert as described in drawing "C". Our CNC machining centre allows moldingknives.com to make knives which are exact mirror images of the dowelling knife which you order. With this knife you can make an insert which precisely aligns the blank and makes the machining operation and life in general a whole lot easier.

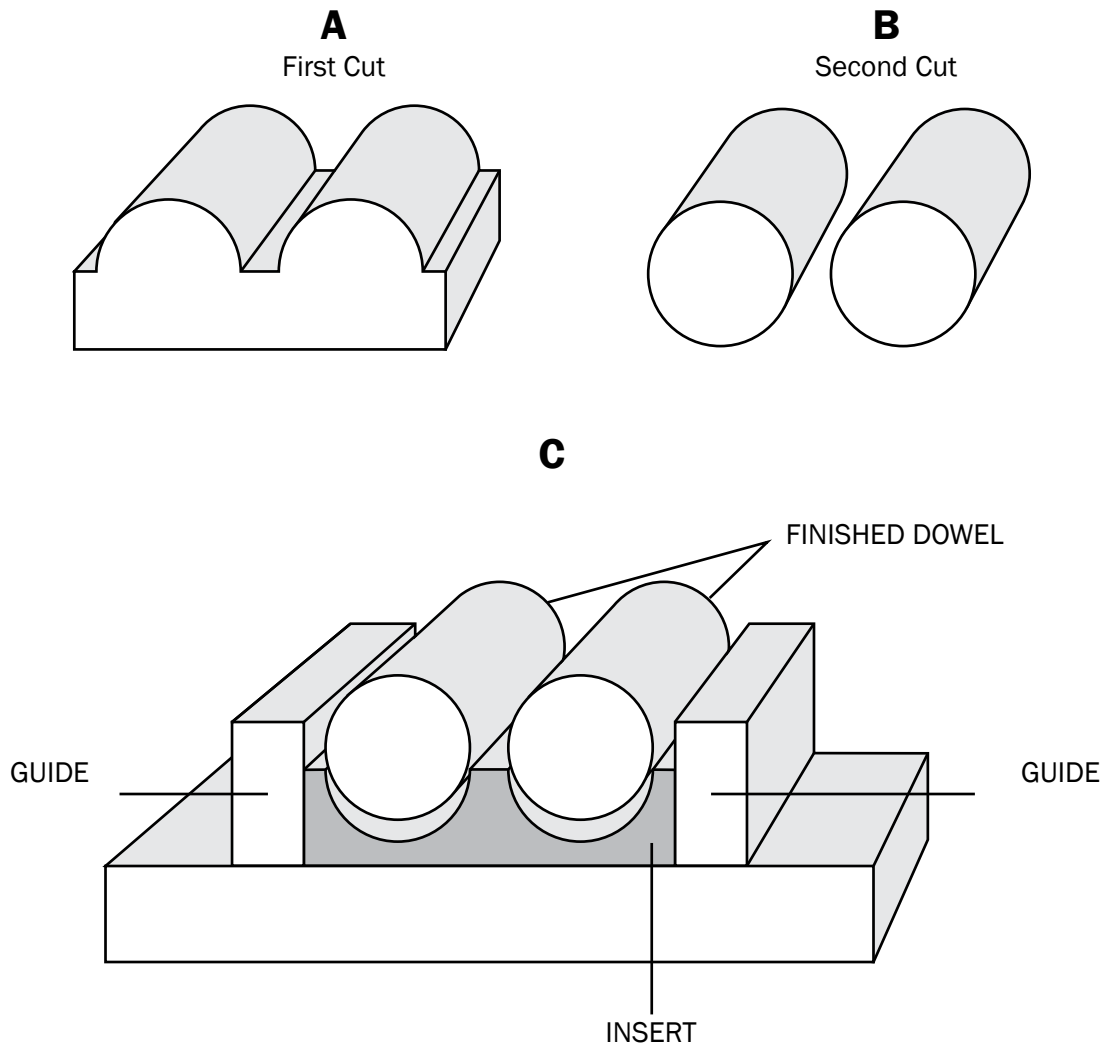

DOWELLING / HALF ROUNDS

Half round knives will also accomplish dowelling and are recommended in 2-up knives.

These knives are available in a great variety of sizes. Check with us!

These knives require the use of a bedboard.

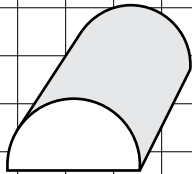
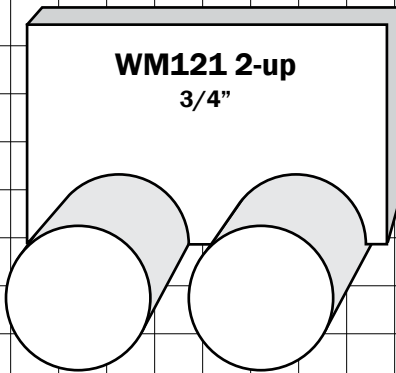

WM122
11/16"

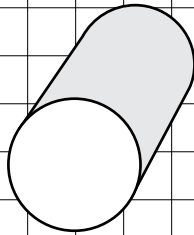

WM123
5/8"

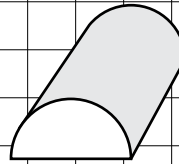

WM124
1/2"

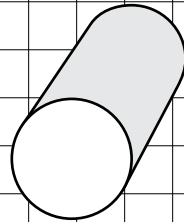

MK0502
7/16"

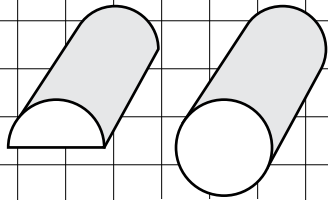

MK0503
3/8"

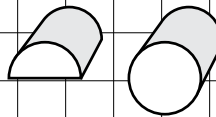

GLASS BEAD

2-up knives available for many of these moldings.

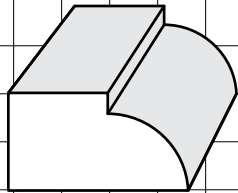

MK0003
1/2" X 15/16"

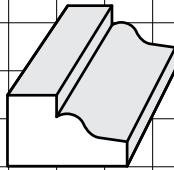

MK0005
3/8" X 5/8"

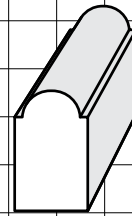

MK0006
5/8" X 3/8"

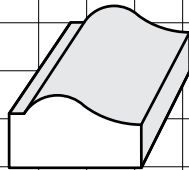

MK0008
3/8" X 11/16"

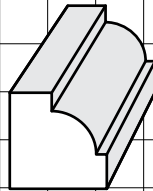

MK0009
1/2" X 1/2"

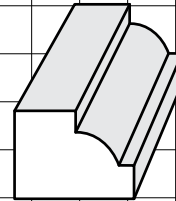

MK0010
5/8" X 3/8"

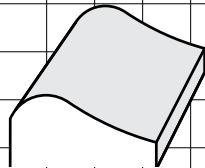

MK0011
3/8" X 3/4"

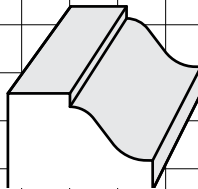

MK0015
1/2" X 3/4"

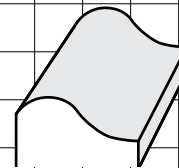

MK0016
3/8" X 5/8"

HAND RAIL

Two cuts using the same knife are required to accomplish these moldings.

Rabbit and tray knives are sold separately.

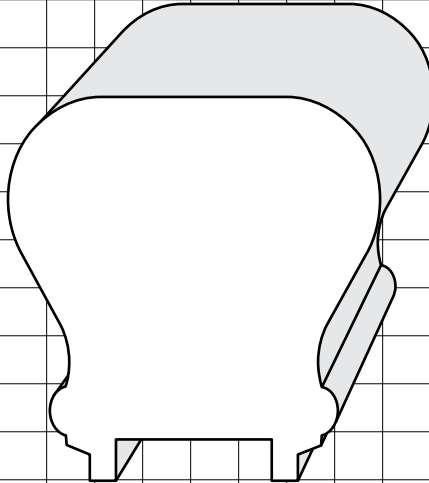

WM1001
1-15/16" X 2"

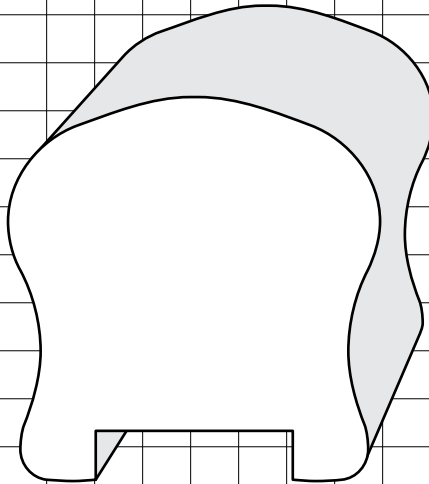

WM1004
1-15/16" X 2"

HEADER

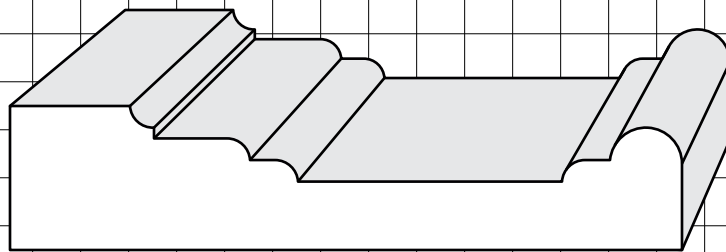

MK0098
3/4" X 3-1/2"

MITRED DOORS

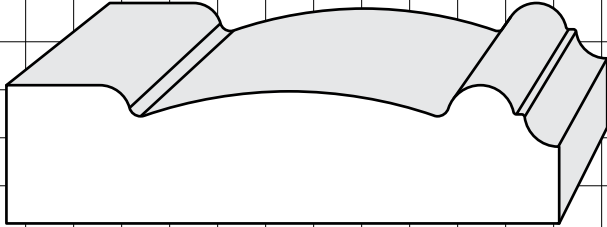

MD001
3/4" X 3"

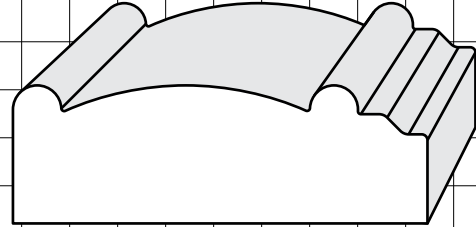

MD005
3/4" X 2-1/4"

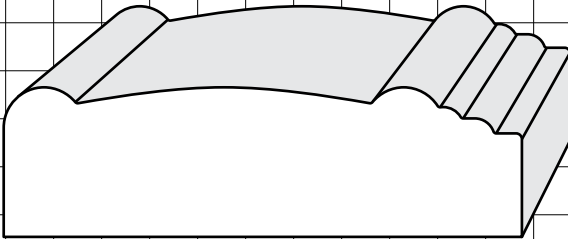

MD002
13/16" X 2-13/16"

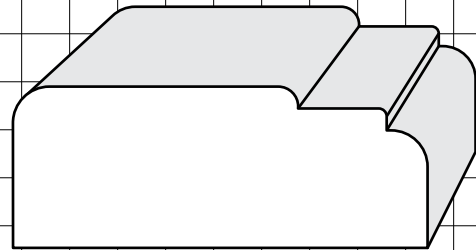

MD006
7/8" X 2-1/4"

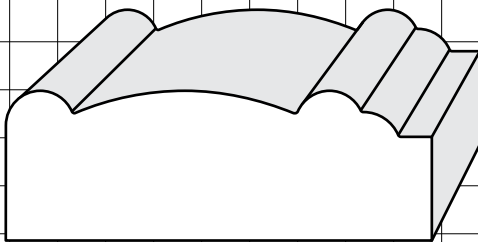

MD003
13/16" X 2-5/16"

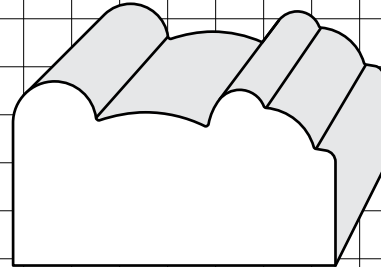

MD007
1" X 1-3/4"

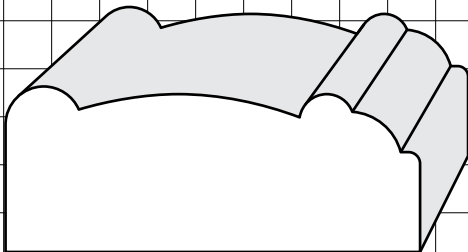

MD004
1" X 2-1/4"

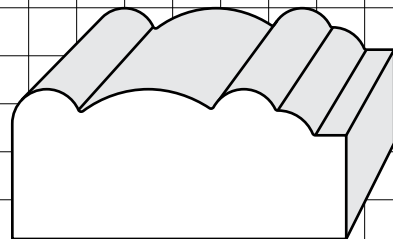

MD008
13/16" X 1-13/16"

MITRED DOORS

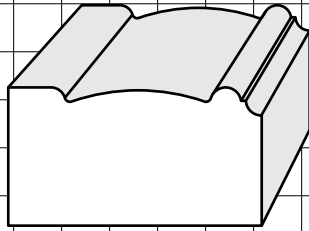

MD009
3/4" X 1-3/8"

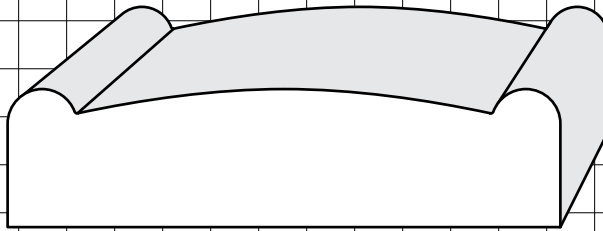

MD010
3/4" X 3"

See our shaper knives catalogue for groove cutters.

PANEL STRIPS / MULLION CASINGS

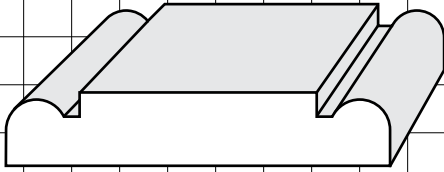

WM955 3/8" X 2-1/4"
 WM956 3/8" X 2" (Illus.)
 WM957 3/8" X 1-3/4"

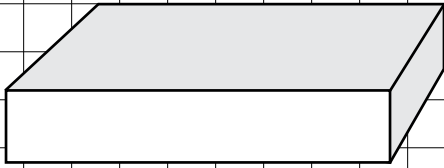

WM960 3/8" X 2-1/4"
 WM962 3/8" X 2" (Illus.)
 WM963 3/8" X 1-3/4"

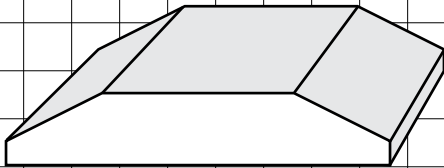

WM965 3/8" X 2-1/4"
 WM967 3/8" X 2" (Illus.)
 WM968 3/8" X 1-3/4"

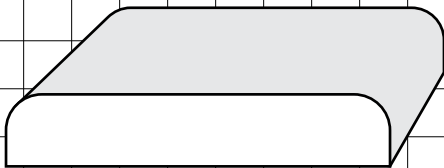

WM970 3/8" X 2-1/4"
 WM972 3/8" X 2" (Illus.)
 WM973 3/8" X 1-3/4"

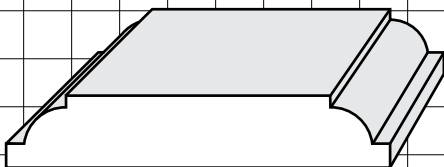

WM975 3/8" X 2-1/4"
 WM977 3/8" X 2" (Illus.)
 WM978 3/8" X 1-3/4"

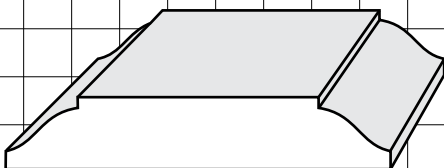

WM980 3/8" X 2-1/4"
 WM982 3/8" X 2" (Illus.)
 WM983 3/8" X 1-3/4"

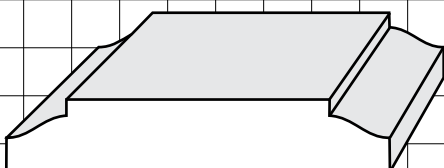

WM985 3/8" X 2-1/4"
 WM987 3/8" X 2" (Illus.)
 WM988 3/8" X 1-3/4"

PICTURE MOLDINGS

Available in top knives, bottom knives, and our popular Versa™ knife style.
These knives require the use of a bedboard.

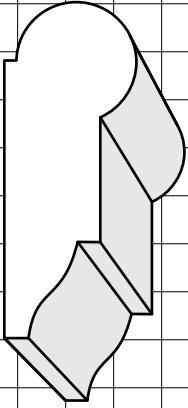

WM273
11/16" X 1-3/4"

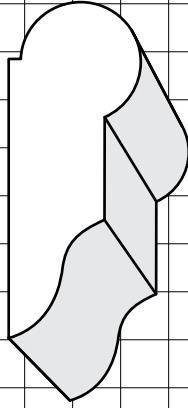

WM276
11/16" X 1-3/4"

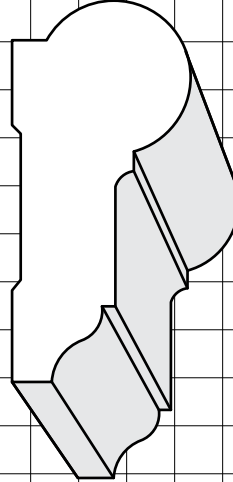

MK0031
15/16" X 2"

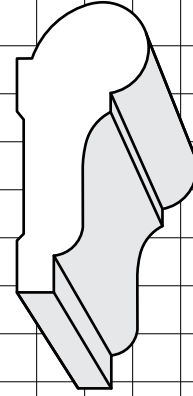

MK0032
11/16" X 1-1/2"

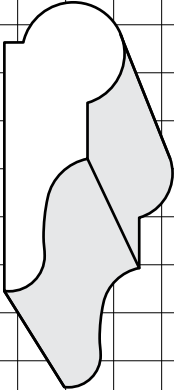

MK0033
5/8" X 1-1/2"

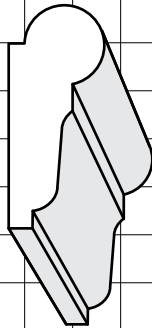

MK0034
1/2" X 15/32"

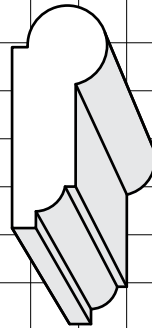

MK0035
1/2" X 15/32"

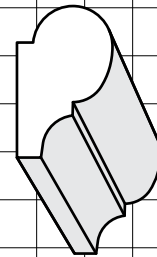

MK0036
25/32" X 1/2"

VERSA KNIFE™

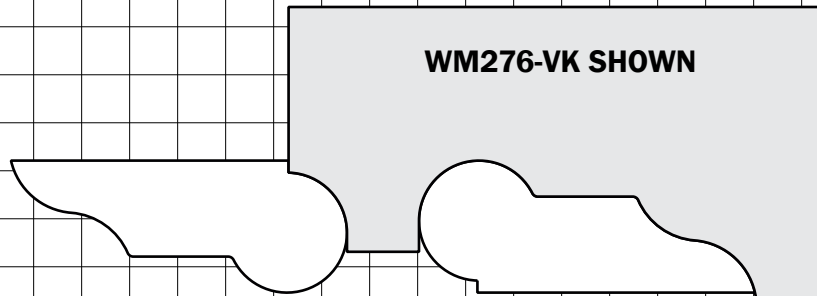

PLANTATION LOUVERS / SHUTTERS

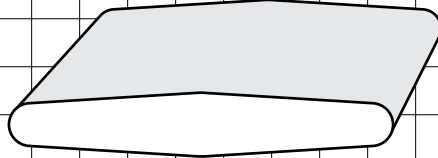

MK0048
21/64" X 2"

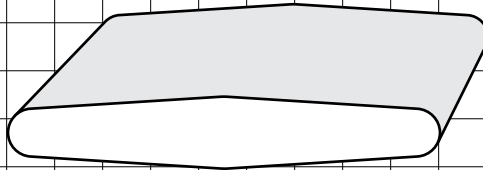

MK0049
3/8" X 2-1/4"

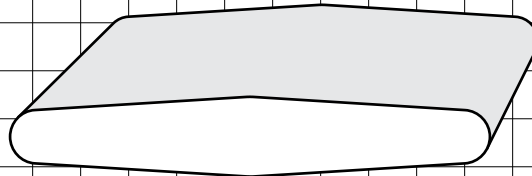

MK0050
27/64" X 2-1/2"

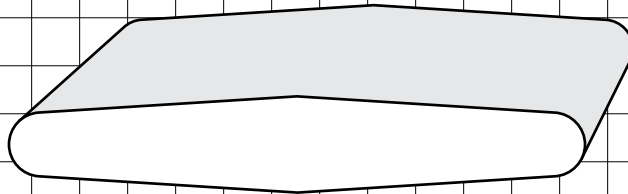

MK0051
1/2" X 3"

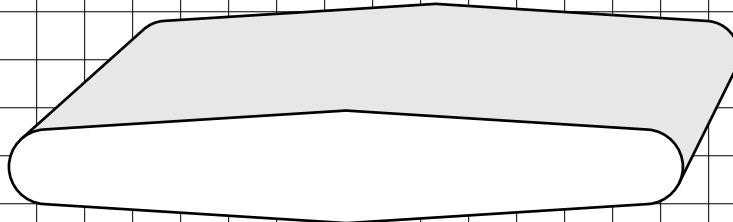

MK0530
19/32" X 3-1/2"

PLANTATION LOUVERS / SHUTTERS

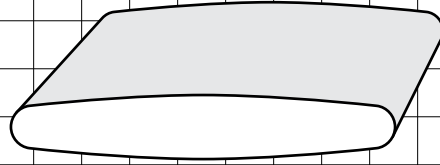

MK0052
21/64" X 2"

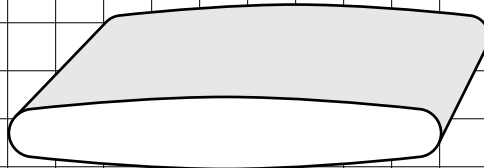

MK0053
3/8" X 2-1/4"

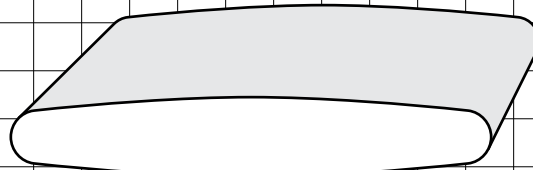

MK0054
27/64" X 2-1/2"

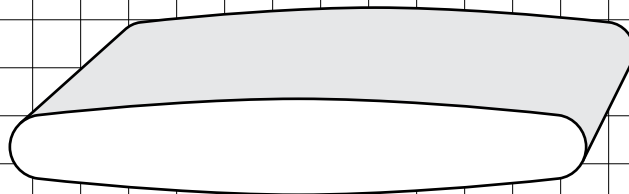

MK0055
1/2" X 3"

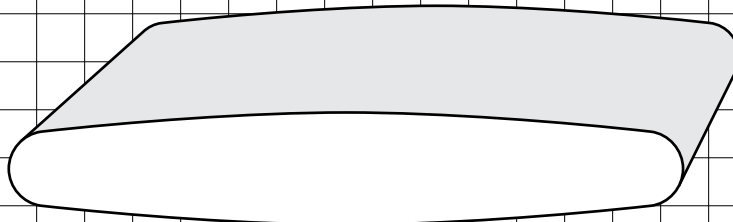

MK0540
19/32" X 3-1/2"

PLANTATION LOUVERS / SHUTTERS



MK0056
21/64" X 2"

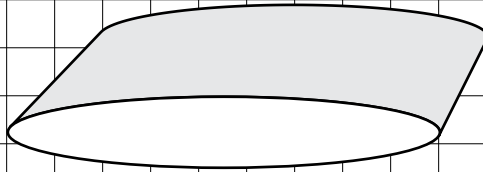

MK0057
3/8" X 2-1/4"

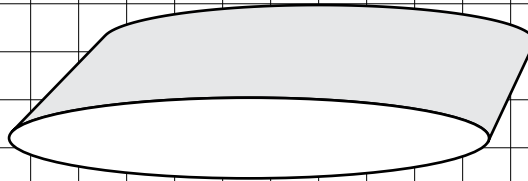

MK0058
27/64" X 2-1/2"

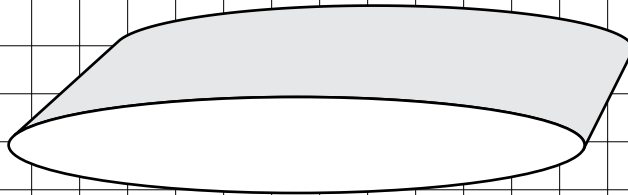

MK0059
1/2" X 3"

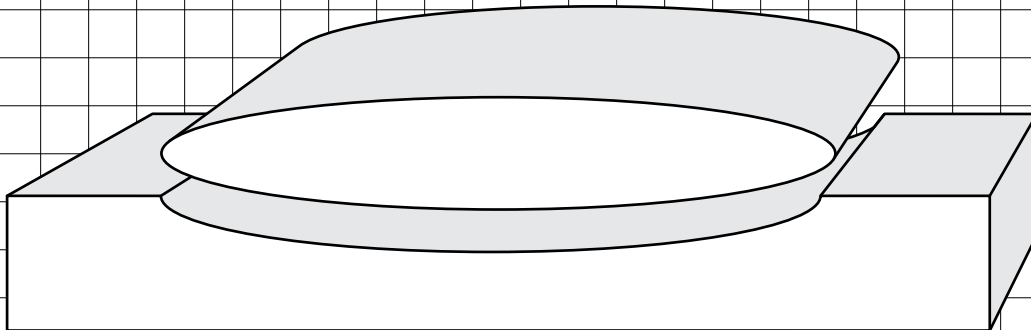

MK0550 (shown with tray)
19/32" X 3-1/2"

QUARTER ROUNDS

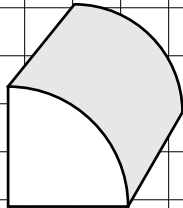

WM107
5/8" X 5/8"

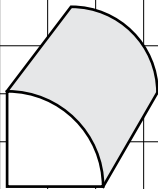

WM108
1/2" X 1/2"

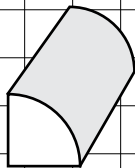

WM109
3/8" X 3/8"

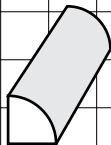

WM110
1/4" X 1/4"

SHELF EDGE / SCREEN MOLD

*These knives require the use of a bedboard.

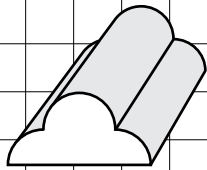

WM137*
3/8" X 3/4"

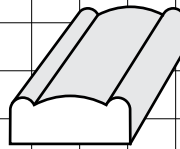

WM141
1/4" X 5/8"

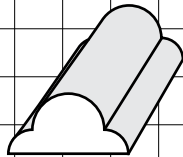

WM138*
5/16" X 5/8"

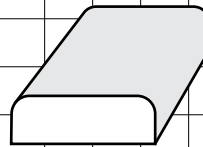

WM142
1/4" X 3/4"

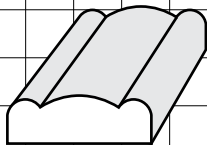

WM140
1/4" X 3/4"

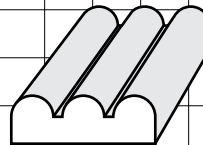

WM144
1/4" X 3/4"

SHINGLE / PANEL MOLDINGS

Open-ended knives are available for these profiles.

*These knives require the use of a bedboard.

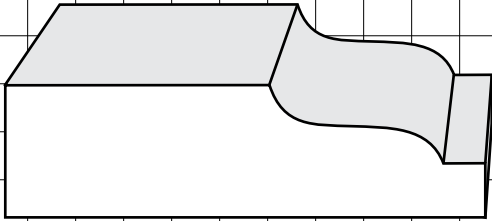

WM207
11/16" X 2-1/2"

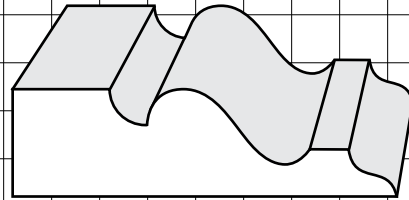

WM213*
9/16" X 2"

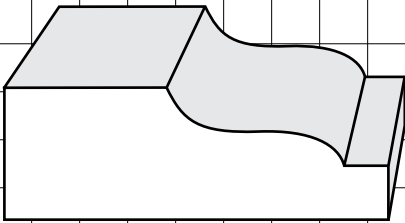

WM209
11/16" X 2"

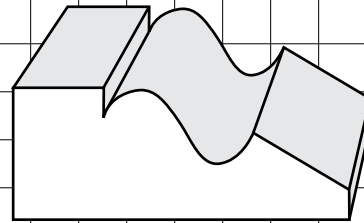

WM217
11/16" X 1-3/4"

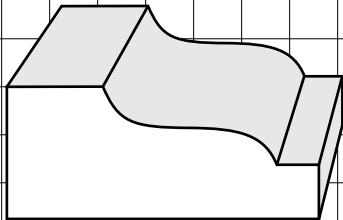

WM210
11/16" X 1-5/8"

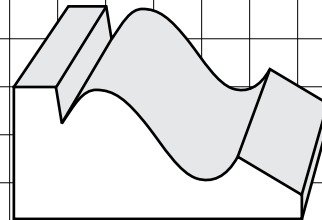

WM218
11/16" X 1-1/2"

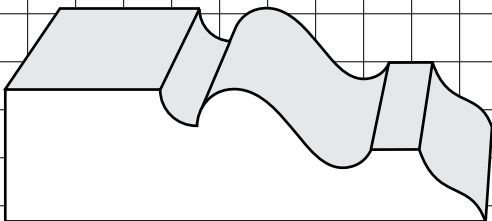

WM212*
11/16" X 2-1/2"

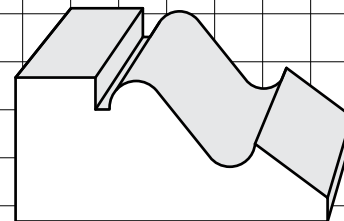

MK0042
3/4" X 1-5/8"

STOPS

Open-ended knives are available for some of these profiles.
 These knives require the use of a bedboard.

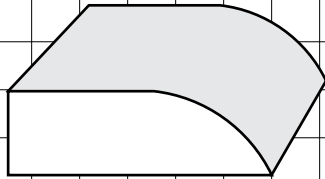

- WM813** 7/16" X 2-1/4"
- WM814** 7/16" X 1-3/4"
- WM815** 7/16" X 1-5/8"
- WM816** 7/16" X 1-3/8"
- WM817** 7/16" X 1-1/4"
- WM818** 7/16" X 1-1/8"
- WM820** 7/16" X 7/8"

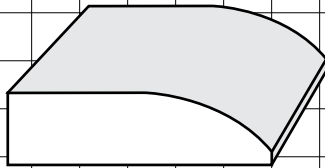

- WM853** 3/8" X 2-1/4"
- WM854** 3/8" X 1-3/4"
- WM855** 3/8" X 1-5/8"
- WM856** 3/8" X 1-3/8"
- WM857** 3/8" X 1-1/4"
- WM858** 3/8" X 1-1/8"
- WM860** 3/8" X 7/8"
- WM861** 3/8" X 3/4"

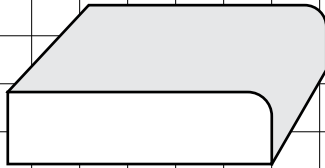

- WM883** 3/8" X 2-1/4"
- WM884** 3/8" X 1-3/4"
- WM885** 3/8" X 1-5/8"
- WM886** 3/8" X 1-3/8"
- WM887** 3/8" X 1-1/4"
- WM888** 3/8" X 1-1/8"
- WM890** 3/8" X 7/8"
- WM891** 3/8" X 3/4"

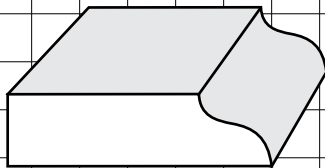

- WM913** 3/8" X 2-1/4"
- WM914** 3/8" X 1-3/4"
- WM915** 3/8" X 1-5/8"
- WM916** 3/8" X 1-3/8"
- WM917** 3/8" X 1-1/4"
- WM918** 3/8" X 1-1/8"
- WM920** 3/8" X 7/8"
- WM921** 3/8" X 3/4"

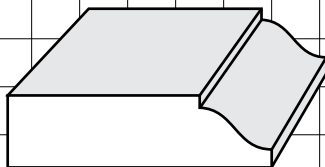

- WM943** 3/8" X 2-1/4"
- WM944** 3/8" X 1-3/4"
- WM945** 3/8" X 1-5/8"
- WM946** 3/8" X 1-3/8"
- WM947** 3/8" X 1-1/4"
- WM948** 3/8" X 1-1/8"
- WM950** 3/8" X 7/8"
- WM951** 3/8" X 3/4"

TONGUE AND GROOVE

You can easily manufacture T&G for boarding in, flooring or panelling on your planer molder. The accuracy of your T&G will be in direct proportion to the accuracy of your setup. It is imperative that the work piece is held upright and on center in relationship to the cutter when being machined. This can be easily accomplished by building guides that have a raised insert directly under the cutter head. The advantage of the insert guides will become apparent the first time you use them.

Traditional guides that grip the stock tightly for the full length will quickly spread and jam when you feed through the first piece of lumber with a slight twist in it. The insert grips the lumber tightly directly under the cutting head for a distance of 4" only, allowing the stock to feed accurately and smoothly.

The insert can be made from kiln dried maple or other fine grained hardwoods or white poly (plastic). In the drawings we have used an insert which is 5/16" thick. The guide has been routed out to a depth of 1/4" to accommodate the inserts width and height. IT IS EXTREMELY IMPORTANT TO CHAMFER THE LEADING EDGE OF THE INSERT as shown. The insert now protrudes 1/16" from the guide. It is fastened to the guide with countersunk screws.

The guides should support the stock within 3/4" of the top edge (For a 4" wide board build the guide 3-1/4" high). The guides must be properly aligned in relationship to the head before fastening them to the bedboard.

Before starting production accurately pre-size your stock.

Run test pieces, and when alignment is correct, machine the groove in your entire run. Disconnect power and move the knife into the correct position to run tongue. NOTE: You will find it easier to move the knife rather than your guides. To double production and help prevent premature roller wear, consider using a second knife and guide. This will enable you to run two pieces of groove or two pieces of tongue at the same time.

TONGUE AND GROOVE

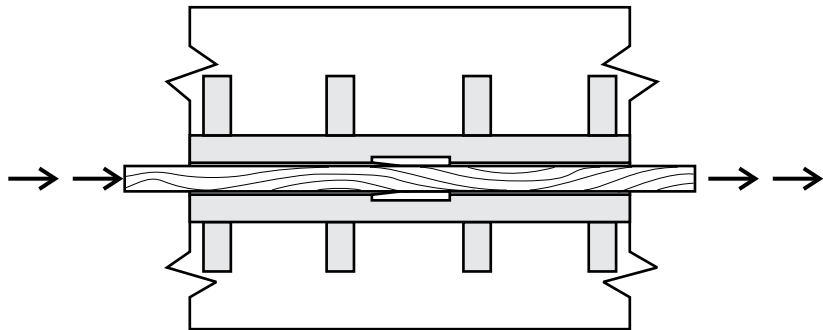

TOP VIEW

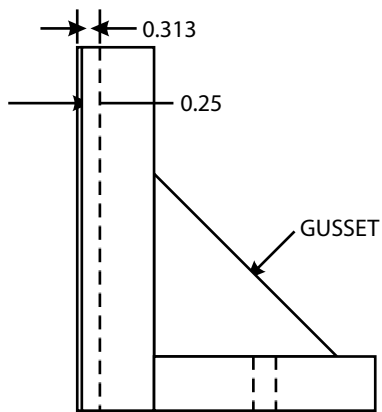

END VIEW

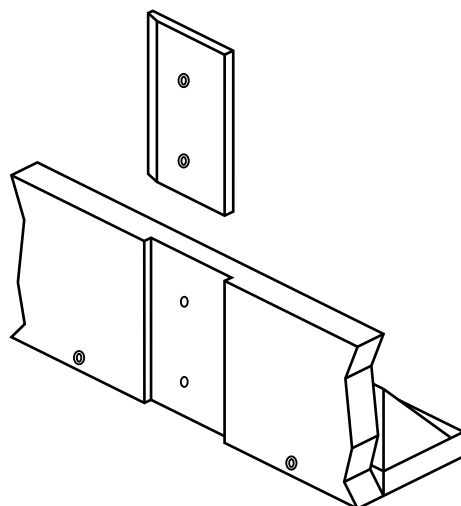

ISO VIEW

TONGUE AND GROOVE - STANDARD

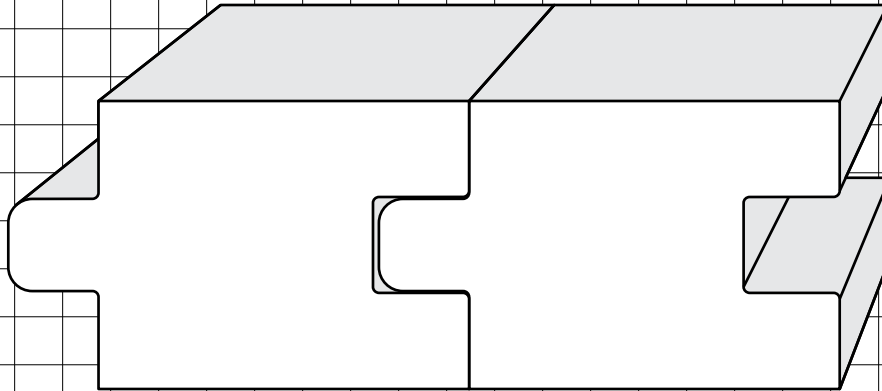

CK389
1-1/2"

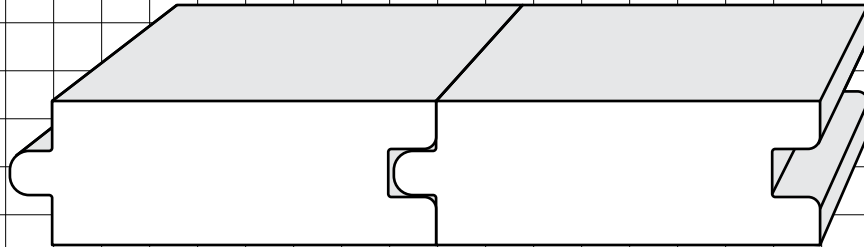

CK388
3/4"

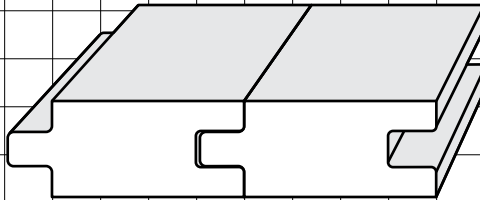

CK386
1/2"

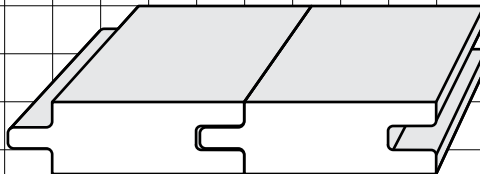

CK385
3/8"

TONGUE AND GROOVE - V-JOINT

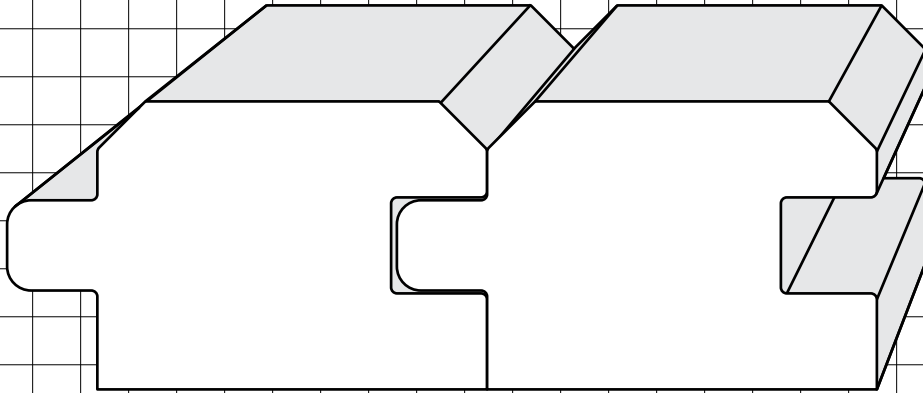

CK389V
1-1/2"

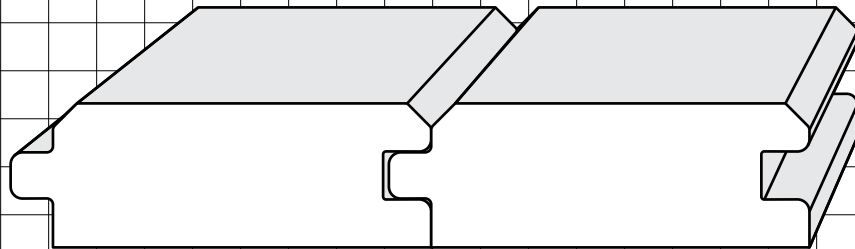

CK388V
3/4"

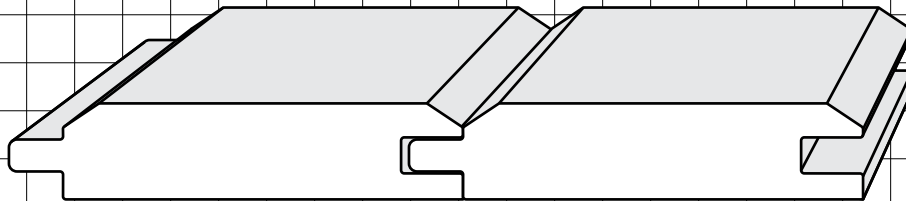

CK386V
1/2"

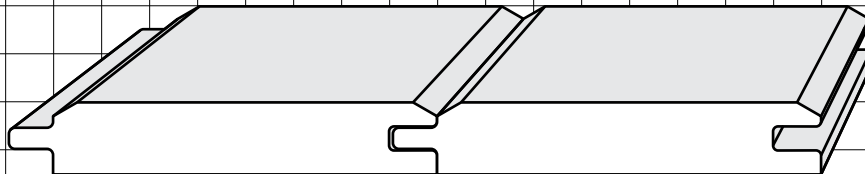

CK385V
3/8"

TONGUE AND GROOVE - DOUBLE V-JOINT

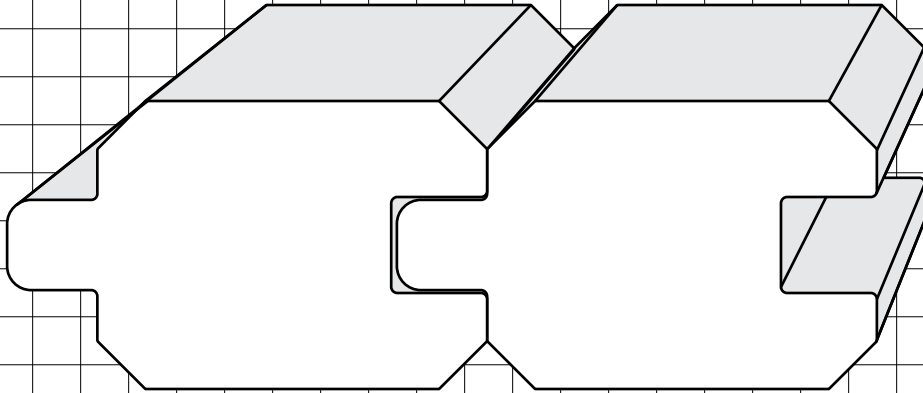

CK389DV
1-1/2"

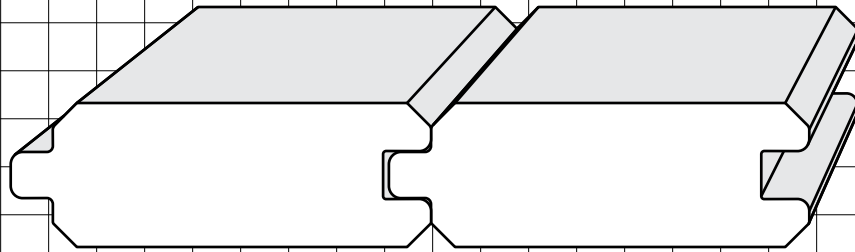

CK388DV
3/4"

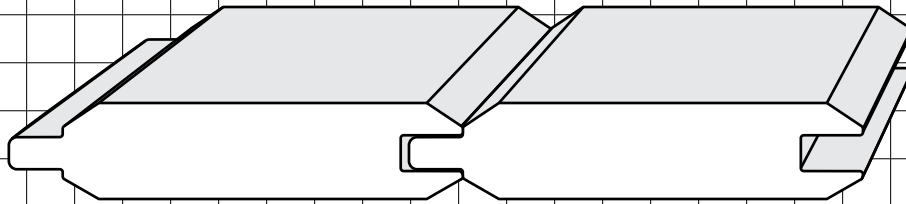

CK386DV
1/2"

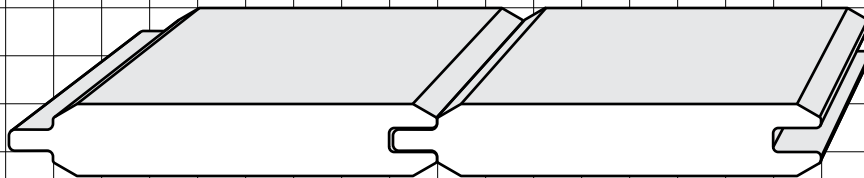

CK385DV
3/8"

TONGUE AND GROOVE - MICRO V-JOINT

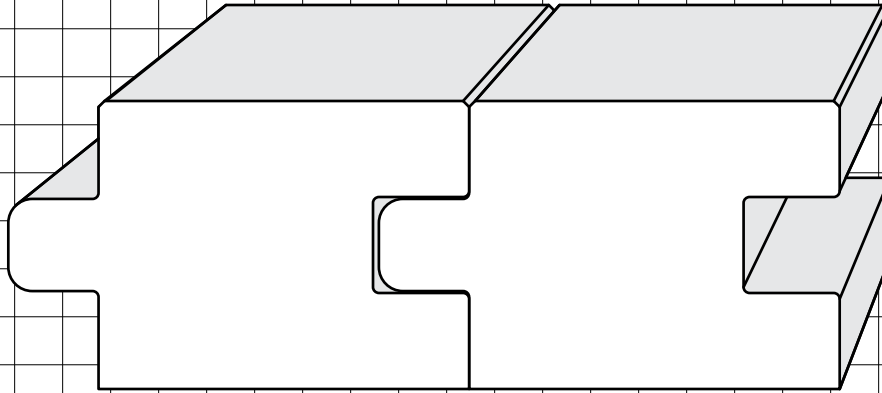

CK389MV
1-1/2"

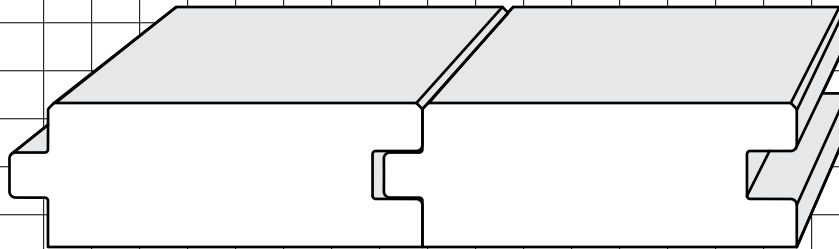

CK388MV
3/4"

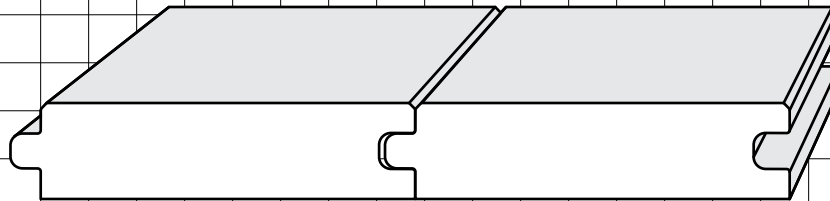

CK386MV
1/2"

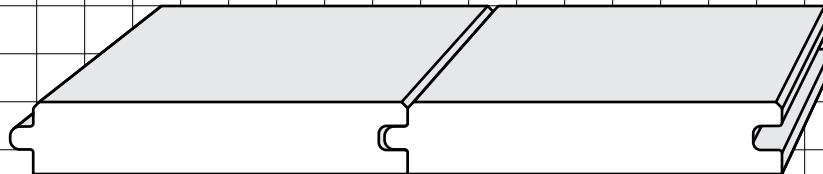

CK385MV
3/8"

TONGUE AND GROOVE - DOUBLE MICRO V-JOINT

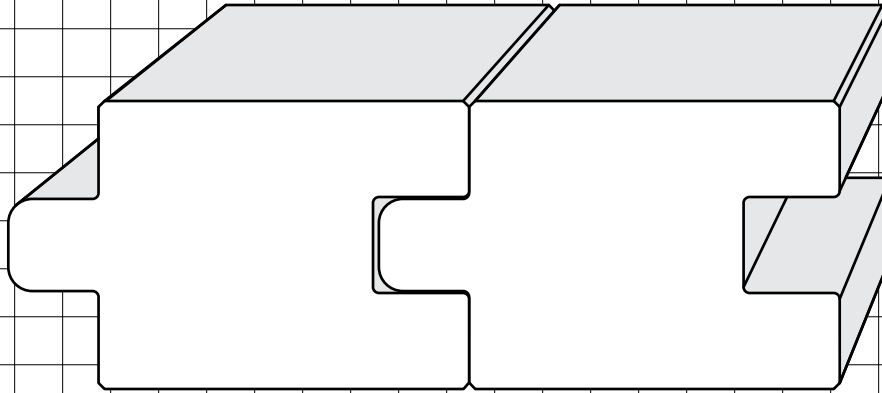

CK389DMV
1-1/2"

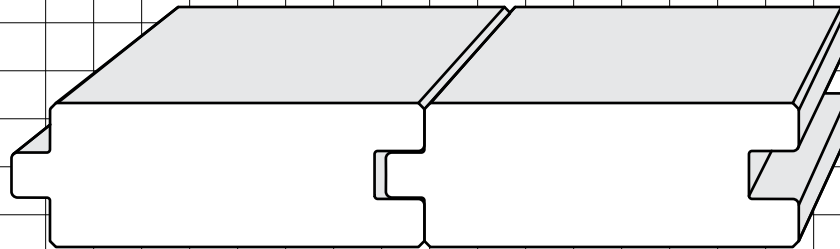

CK388DMV
3/4"

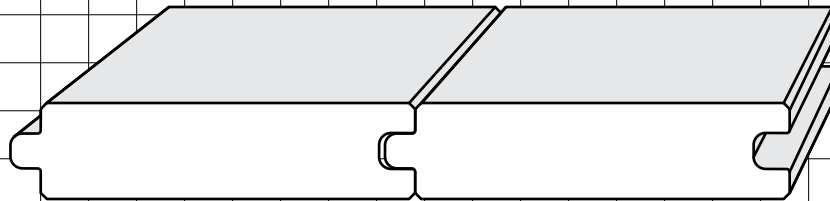

CK386DMV
1/2"

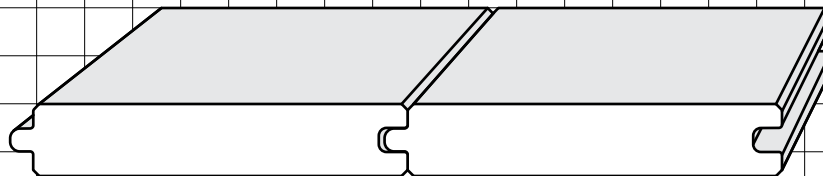

CK385DMV
3/8"

TONGUE AND GROOVE - FLOORING

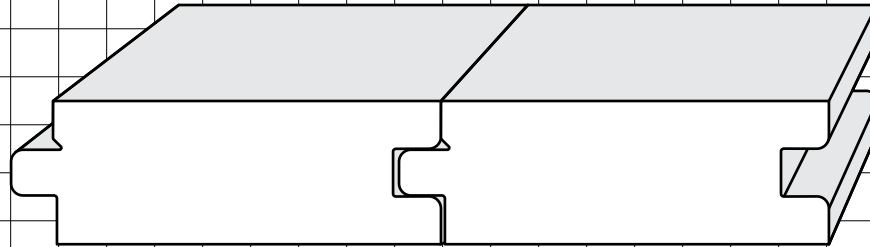

CK384A
3/4"

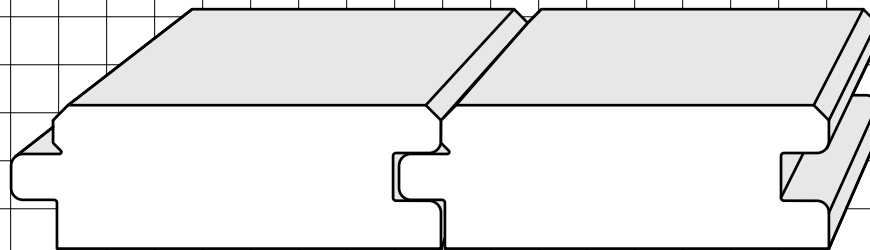

CK384B
3/4"

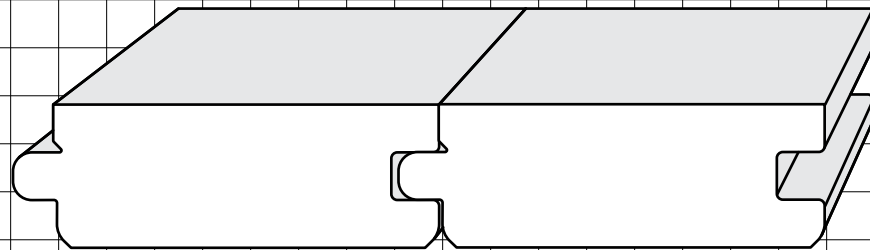

CK384C
3/4"

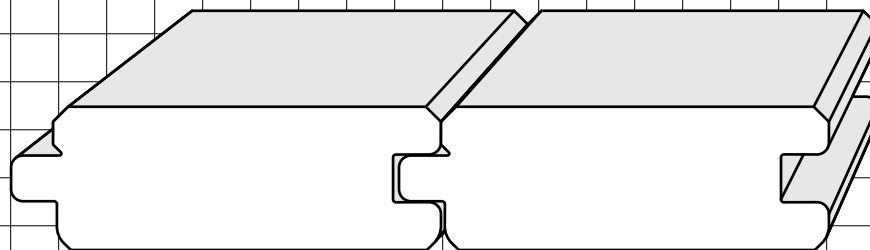

CK384D
3/4"

TONGUE AND GROOVE - FLOORING

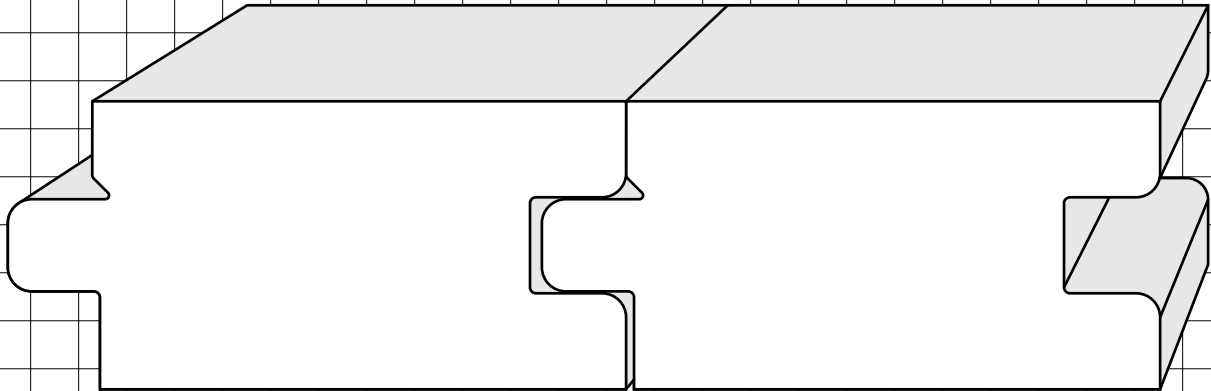

CK384E
1-1/2"

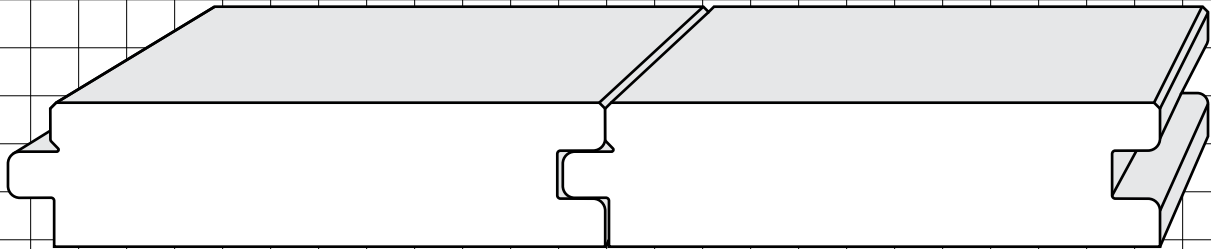

CK384F
3/4"

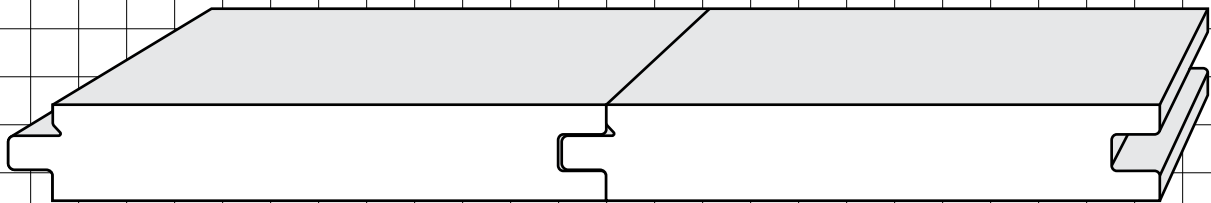

CK384H
1/2"

V's

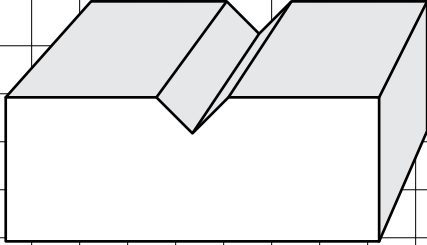

MK0954

3/8" wide X 3/16" deep

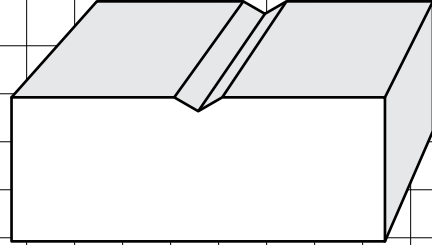

MK0957

1/4" wide X 1/16" deep

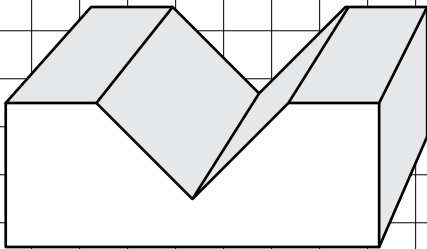

MK0955

1" wide X 1/2" deep

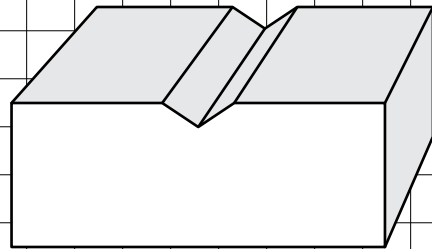

MK0958

3/8" wide X 1/8" deep

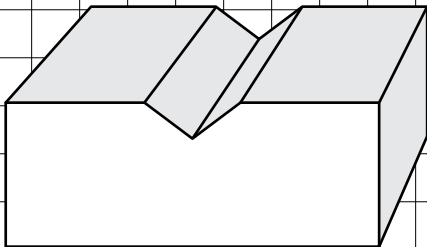

MK0956

1/2" wide X 3/16" deep

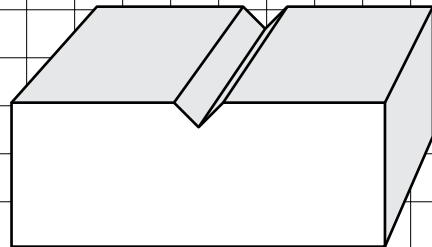

MK0110

1/4" wide X 1/8" deep

WAINSCOT / PLYCAP MOLDINGS

Rabbit knives are sold separately.

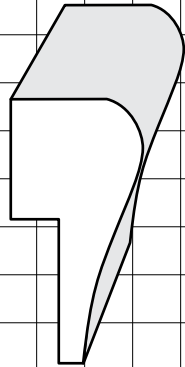

WM290
11/16" X 1-3/8"

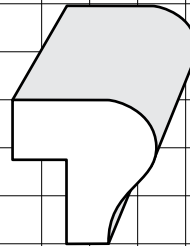

WM296
3/4" X 3/4"

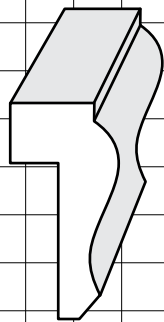

WM292
9/16" X 1-1/8"

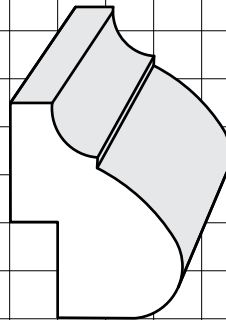

MK0041
7/8" X 1-1/8"

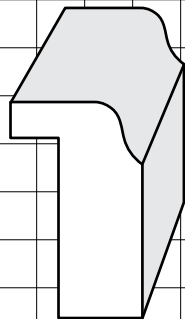

WM294
11/16" X 1-1/8"

WAINSCOTTING

Rabbit knives are sold separately.

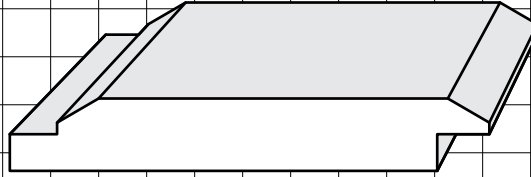

WM6000
3/8" X 2-1/2"

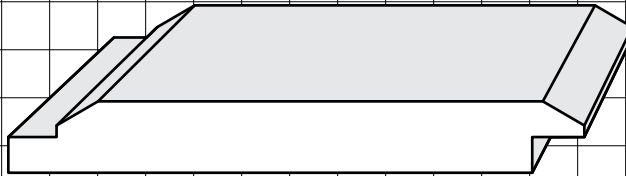

WM6001
3/8" X 3"

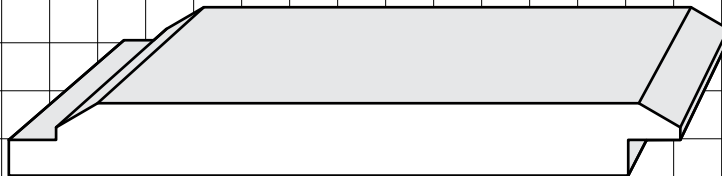

WM6002
3/8" X 3-1/2"

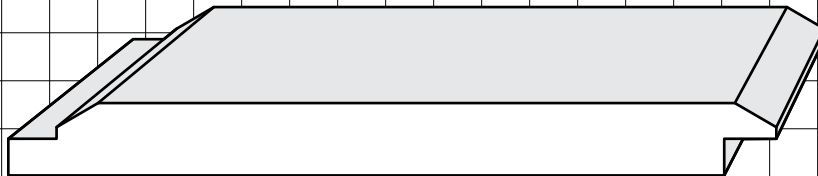

WM6003
3/8" X 4"

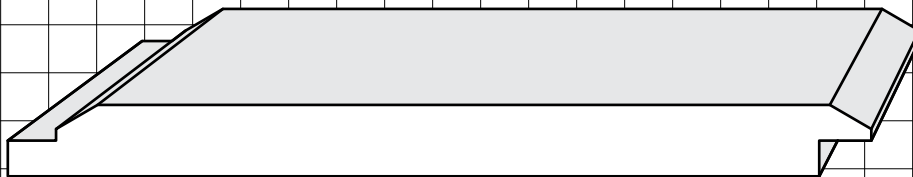

WM6004
3/8" X 4-1/2"

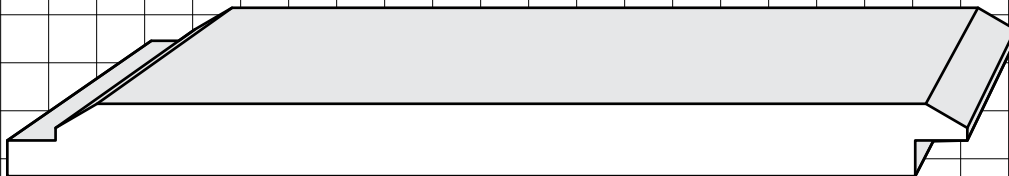

WM6005
3/8" X 5"

WAINSCOTTING

Rabbit knives are sold separately.

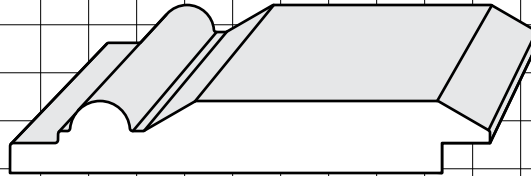

WM6006
3/8" X 2-1/2"



WM6007
3/8" X 3"

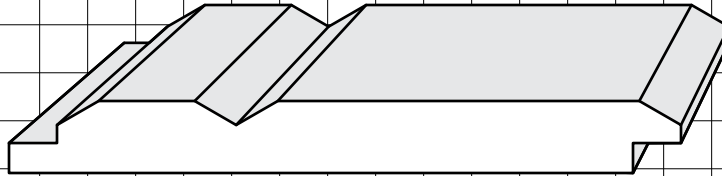

WM6008
3/8" X 3-1/2"

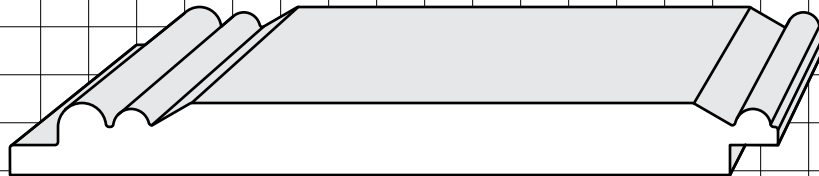

WM6009
3/8" X 4"

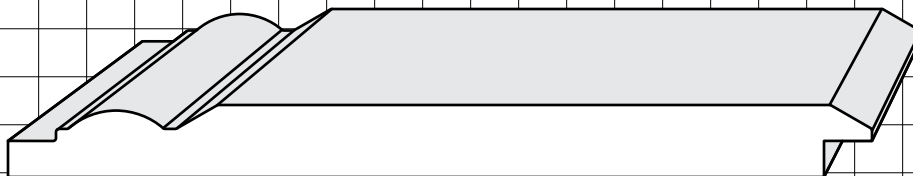

WM6010
3/8" X 4-1/2"

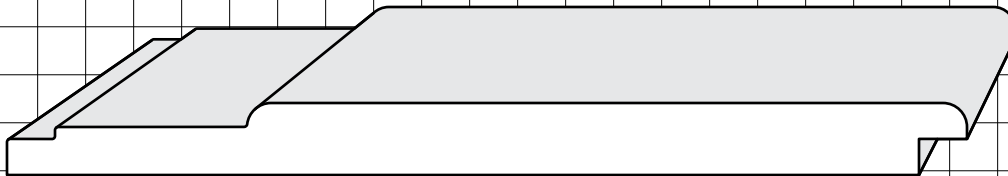

WM6011
3/8" X 5"

WOOD PLANK PANELLING / SIDING

There is a very strong and growing demand for decorative solid plank panel used in both the restoration and new home market. Solid wood makes a profound statement – QUALITY. In addition to the warmth and beauty that solid wood radiates, it also provides structural strength, and the great majority of wood is friendly to those of us who suffer from allergies.

Many of the patterns shown will be familiar to the experienced builder, as they are industry standard. In addition we have created a number of variations to meet the growing demand for today's market. The 5-1/2" pattern shown is by far the most popular width with our customers; however, we will be pleased to design and manufacture knives to meet your requirements. For that special project, we can match just about any pattern you may need for restoration work or custom design.

The manufacturing of wood panel and siding has an added benefit; it is a great way for saw-millers to add value to the lower grades of sound lumber they produce. In addition to the existing market for clear wood panelling, "rustic" panel and siding is in demand. Knotty pine and cedar have long been traditional favorites and a growing number of builders are now using lower grade hardwoods for interior panel. Sound knots and color variations in the wood can be very pleasing in the right setting.

You will require a matched set of three knives for the pattern face of the panel, and an additional matched set of three rabbet knives to machine the rabbet in the back face of each panel. These knives are to be used in the planer head. In many cases, one set of rabbet knives can be used to machine a variety of different panel designs. Panel and log cabin siding is very easily machined and can be a real money-maker. Remember to use wood with a moisture content of between 6% and 8% for interior panel. Exterior panel and siding should be manufactured from wood that has been dried to at least 12% moisture content.

WOOD PLANK PANELLING

Rabbit knives are sold separately.

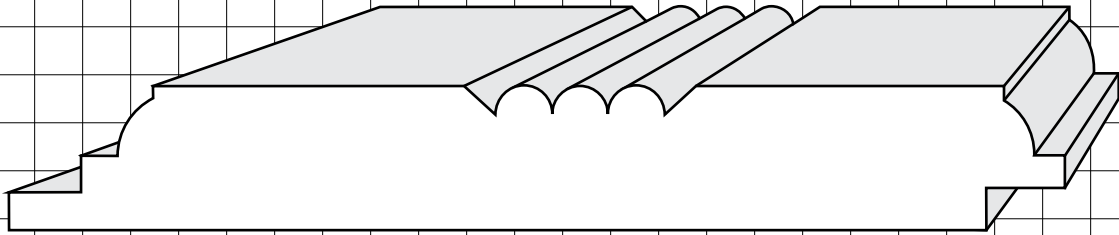

PS81
3/4" X 5-1/2"

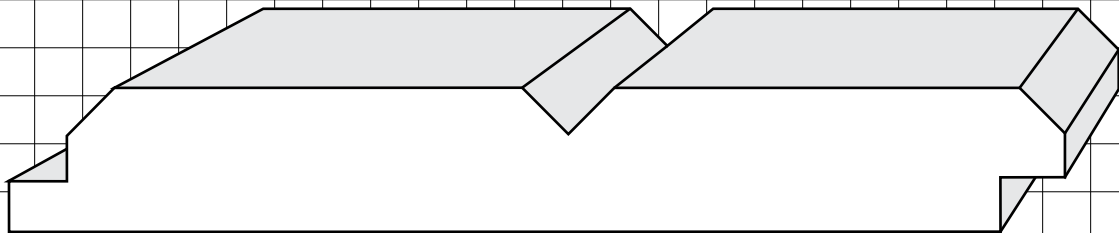
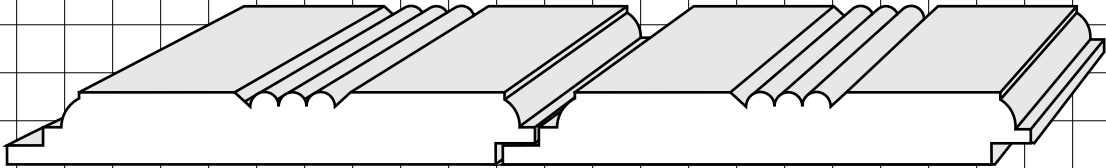

PS83
3/4" X 5-1/2"

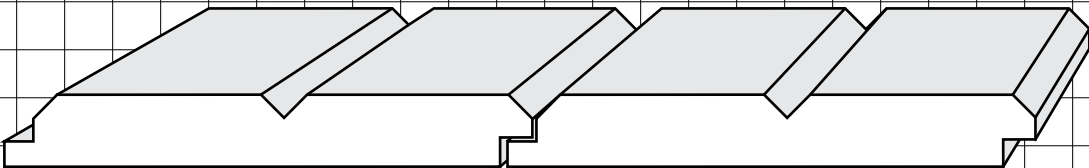

WOOD PLANK PANELLING

Rabbit knives are sold separately.

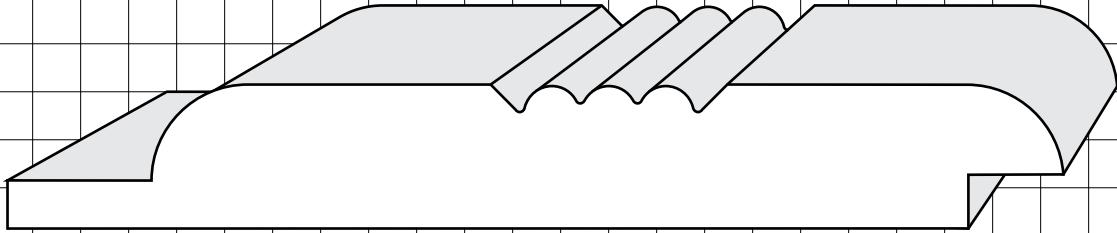

PS84
3/4" X 5-1/2"

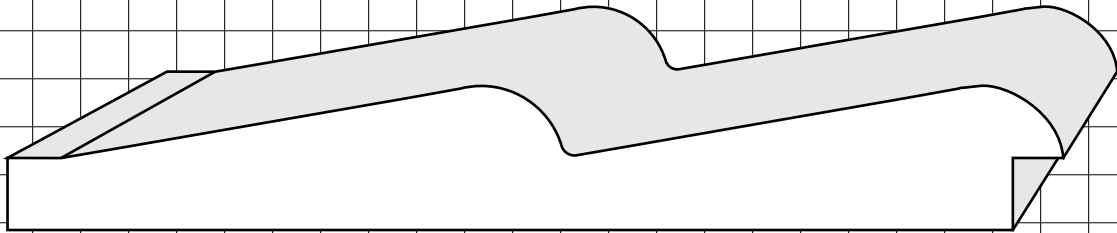
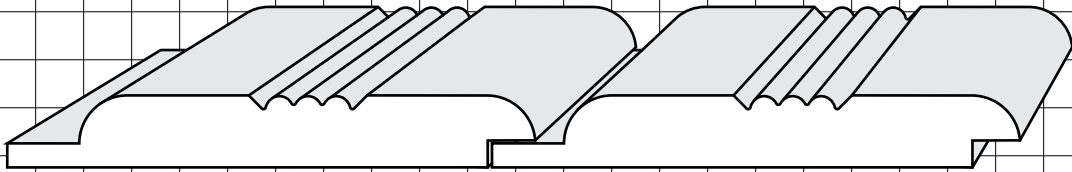

PS85
3/4" X 5-1/2"

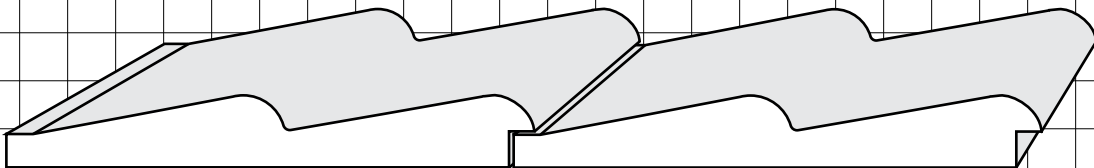

WOOD PLANK PANELLING

Rabbit knives are sold separately.

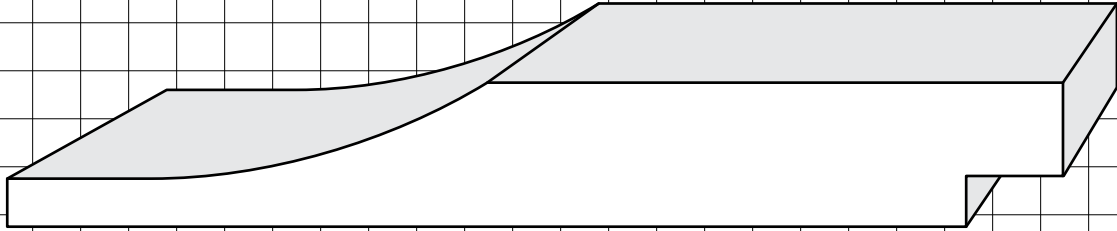

PS86
3/4" X 5-1/2"

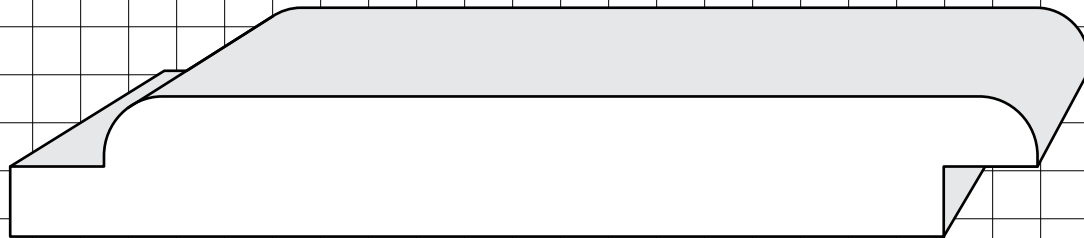
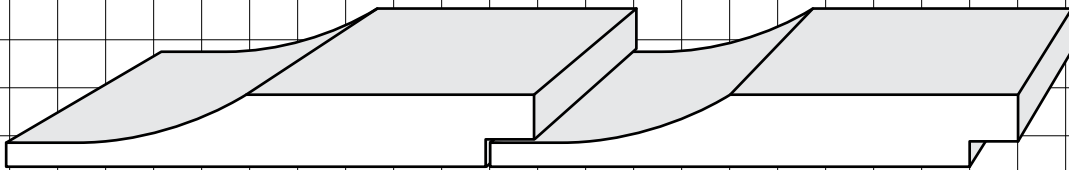

PS87
3/4" X 5-1/2"

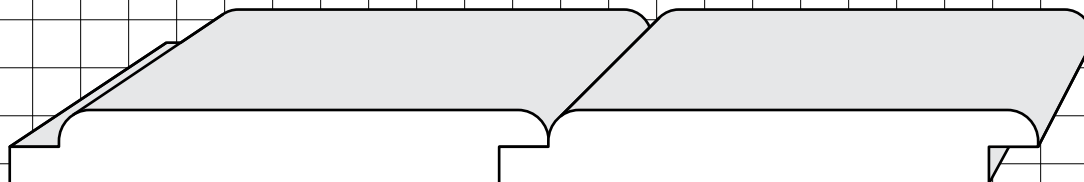

WOOD PLANK PANELLING

Rabbit knives are sold separately.

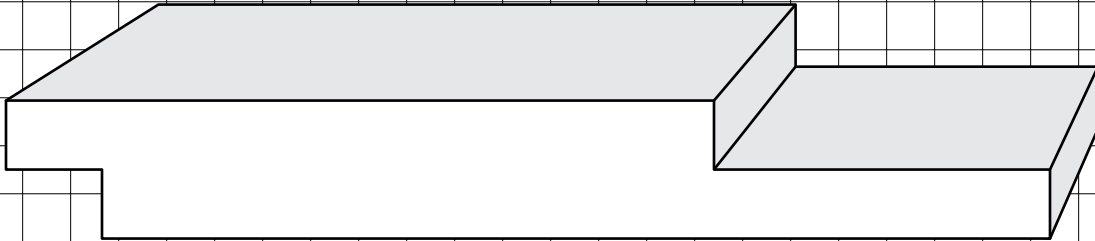

PS150

22/32" X 5-7/16"

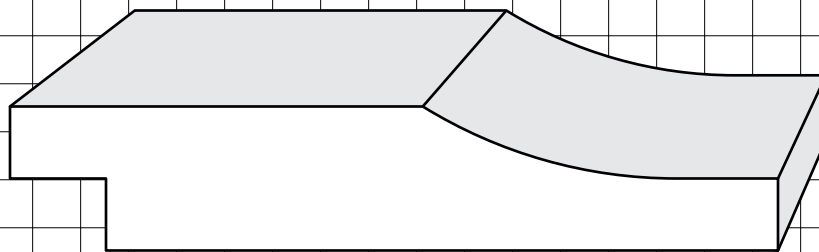

MK0085

3/4" X 4"

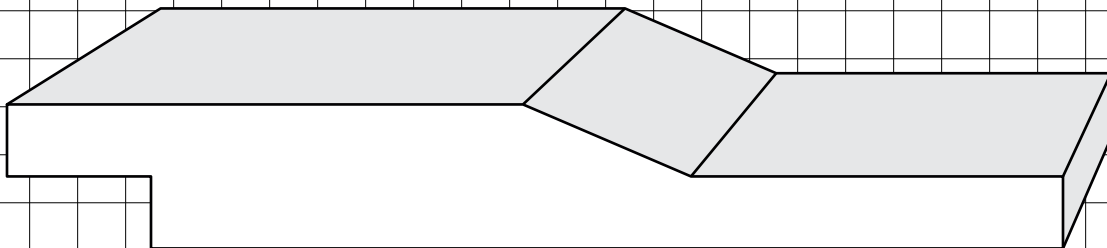

MK0180

3/4" X 5-1/2"

MOLDINGKNIVES.COM CUSTOM PATTERN KNIVES

Each moldingknives.com knife (see fig. A) includes one (1) 1/4" thick, super high speed steel profile knife (A-1) and one (1) gib (A-2) to secure the knife. The knife will also be supplied with two (2) sets of steel weights (A-3) and gibs (A-4) for counter-balancing the cutter head.

CAUTION: Each moldingknives.com profile knife is carefully ground, weighed and correctly matched to the gib and counter-balances included with that particular knife. Keep each knife with its own gib and weights. Never use gibs or weights from any other custom knives

you may have purchased. Use of improperly matched gibs and weights may cause excessive vibration and damage to the cutter head bearings.

Fig. B shows correct knife installation sequence in the cutter head. Note the relief angle of the knife in relationship to the direction of rotation.

IMPORTANT: After running approximately 10 linear feet, stop and unplug all power going to the machine, and retighten the gibs!

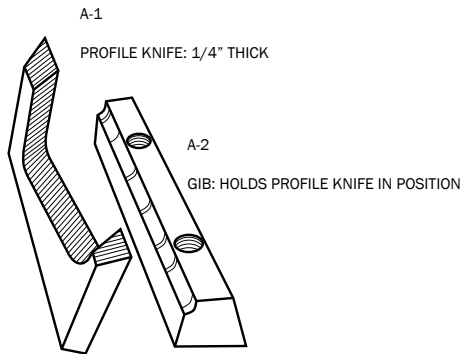

FIG. A

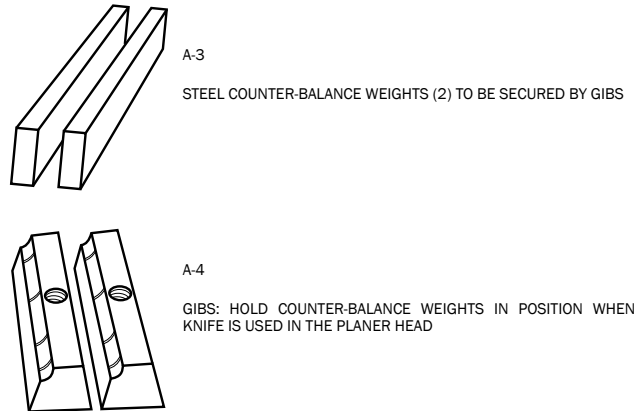
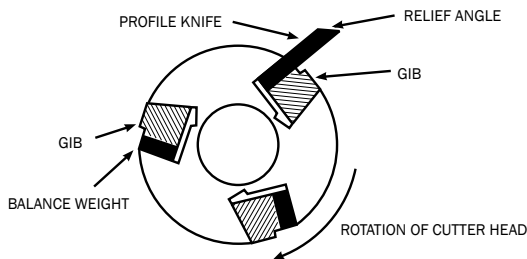

FIG. B



**KNIFE ARRANGEMENT
WHEN USED IN THE PLANER HEAD**

To maintain cutter head balance, use pattern knife with gib in one slot, use gib and one counter-weight in second and third slots.

THE EASY WAY TO ORDER KNIVES

TOLL FREE ORDER LINE: 1-866-499-8399

FAX: 1-902-893-7890

EMAIL: sales@moldingknives.com

Choose from our selection of over 400 stock patterns found in this catalogue. (We have a lot more profiles online at moldingknives.com). Charge your purchase to Visa, MasterCard, American Express, Discover, or PayPal and we will ship THE SAME DAY (on orders placed before 1PM Eastern Time).

CUSTOM KNIVES: Fax or email an accurate, full size drawing with the width and thickness measurements clearly marked, or send us an actual sample by Post or FedEx (please contact us before sending by any other method). In most cases, custom knives are manufactured and shipped within one full business day from receipt of your order.

RUSH ORDERS: Next day delivery is available to most parts of the United States and Canada. Please order early in the morning to take advantage of this service. We ship worldwide by courier.

PAYMENT: Payment may be made by Visa, MasterCard, American Express, Discover, money order, or PayPal.

QUESTIONS: We encourage you to call when placing an order. Our staff has experience with several brands of molders, as well as shapers, and we offer FREE advice and instruction sheets to our customers. Advice that may save you time and money.

Please check online for both updates and to view catalogues for knives that fit specific machines. <http://www.moldingknives.com>

MAIL ORDERS: Send your order to:

MOLDINGKNIVES.COM
1176 Black Rock Road
Clifton, N.S. B6L 1C1
Canada

TO ORDER

CALL TOLL FREE: 1-866-499-8399



moldingknives.com

1176 Black Rock Road, Clifton, N.S.

B6L 1C1

Tel: 1-866-499-8399

Fax: 1-902-893-7890